

Seiberg-Witten Curves, M Theory and $\mathcal{N} = 2$ Dualities

Colin Rylands

September 22, 2012

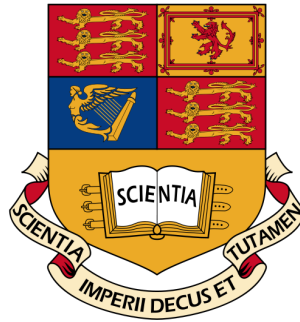

Department of Theoretical Physics
Imperial College London
London, United Kingdom

Submitted in partial fulfillment of the requirements for the degree of Master of
Science in Theoretical Physics at Imperial College London

Supervised by Amihay Hanany

Abstract

The aim of this dissertation is to provide an introduction to Seiberg-Witten curves, their occurrence in string theory and some of their more modern applications. First, the relationship between the Coulomb branch of an $\mathcal{N} = 2$ supersymmetric gauge theory with $G = SU(2)$ and the Seiberg-Witten curve is derived. This is then generalised to include higher rank classical gauge groups and further to cases where matter is included. Following this, the use of string theory in the understanding of these curves covered. The curve will be given a physical interpretation through Type IIA brane configurations and M theory. Recent work using SW curves will then be discussed. New dualities of $\mathcal{N} = 2$ theories can be found by analysing the degenerations of the SW curve. This leads to new classes of SCFTs as well as a different M theory interpretation.

Acknowledgments

I would like to thank my supervisor Amihay Hanany for suggesting this topic and for his excellent taught courses without which this dissertation would not have been viable. Thanks also to Jan Keital, Rob Hogan, Mario Araujo and Nick Hunter-Jones for helpful discussions and support throughout the year .

Contents

1	Introduction	5
2	Seiberg-Witten Gauge Theory	8
2.1	Pure $SU(2)$ Super Yang-Mills	8
2.1.1	R-symmetries and chiral anomaly	8
2.1.2	Moduli Space	10
2.1.3	Low energy Action	10
2.1.4	Duality	12
2.1.5	Central Charge and BPS States	14
2.1.6	Monodromies	15
2.1.7	Seiberg Witten curve	18
2.1.8	Monopole Condensation	21
2.2	$SU(N)$	22
2.2.1	SW Curve	23
2.2.2	Weak Coupling Monodromies	25
2.2.3	Strong Coupling Monodromies	29
2.2.4	SW Differential	32
2.2.5	$SU(2)$ revisited	33
2.2.6	Other Classical Groups	33
2.3	Seiberg-Witten Curves with matter	34
2.3.1	Central Charge and Duality	34
2.3.2	Singularities	35
2.3.3	SW Curves	36

2.3.4	Examples of Curves	38
2.3.5	Theories with $N_f = 2N_c$	39
3	A String Theory Perspective	44
3.1	Type IIA Brane Confiurations, M Theory and Unitary Groups	45
3.1.1	Matter Content	47
3.1.2	Coupling Constants	48
3.1.3	M Theory	49
3.1.4	BPS spectrum	50
3.1.5	Coupling Space	52
3.1.6	Generalisation	52
3.1.7	D6 Branes	54
3.1.8	Generalisation	56
3.1.9	Elliptic Models	57
3.1.10	Coupling Space	60
3.2	Orientifolds and Symplectic and Orthogonal Groups	60
3.2.1	Orientifold 4-planes	60
3.2.2	$SO(2k)$	61
3.2.3	$Sp(2k)$	63
3.2.4	$SO(2k+1)$	64
3.2.5	Adding D4 Flavor	65
3.2.6	Generalisation	66
3.2.7	D6s	67
3.2.8	Elliptic Models	68
3.2.9	Orientifold 6-planes	69
3.2.10	Generalisation	70
3.2.11	$SU(N)$ with symmetric and anti-symmetric matter	72
3.2.12	Elliptic Models	73
4	$\mathcal{N} = 2$ Dualities	78
4.1	AS and G Dualities	79

4.1.1	SU(2)	79
4.1.2	SW Curves	82
4.1.3	Degeneration limits	85
4.1.4	$\mathcal{T}_{n,g}[A_1]$ Theories	87
4.1.5	SU(3)	88
4.1.6	SW Curves	92
4.1.7	Degeneration Limits	96
4.1.8	$\mathcal{T}_{(f_1,f_3),g}[A_2]$	97
4.1.9	SU(N)	98
4.1.10	Gaiotto Duality	99
4.1.11	SW Curves	101
4.1.12	M Theory	103
4.2	Tinkertoys	104
4.2.1	Irregular Punctures	105
4.2.2	Fixtures	106
4.2.3	Cylinders	106
4.2.4	Example: SU(3)	107
5	Conclusion	109

1. Introduction

Invariably when a physics student first encounters quantum field theory it is in the guise of perturbation theory. One solves the vacuum equations of motion and expands about this solution as a power series in terms of the coupling constant. This expansion can be neatly represented in terms of Feynman diagrams along with an accompanying set of rules. One could be forgiven for thinking that perturbation theory is the be all and end all of quantum field theory. In fact one of the most remarkable agreements of theory and experiment, calculation of g_e in QED is done via perturbation theory. Despite these successes perturbative expansions have limited regions of validity, specifically the coupling constant must be small, $\ll 1$. Theories which are strongly coupled, when the coupling constant is of $\mathcal{O}(1)$ or greater, are completely opaque to perturbative techniques. Examples of such theories include QCD.

That life beyond perturbation theory is drastically different can be seen via non-perturbative solutions called solitons. These are finite energy solutions whose energy is inversely proportional to the square of the coupling constant. Thus if all one knew were perturbation theory they would have no hope at all of encountering solitons. The coarsest classification of such solutions is through their codimension, codimension 1 solitons are domain walls or kinks, codimension 2; vortices, codimension 3; monopoles and codimension 4; instantons. Both domain walls and vortices drastically change the spacetime around them. Domain walls as suggested by their name actually partition the spacetime allowing discrete jumps in fields across them. Vortices introduce a logarithmic branch cut in the spacetime. While not having as drastic effects on the spacetime the other two solitons monopoles and instantons will never the less play a vital role in this dissertation.

The most powerful technique one can utilise to study strong coupling aspects of theories is duality. When two different theories describe the same physics it is said there is a duality between them. Generically the two dual theories have differing ranges of validity. Electric-magnetic duality is the archetype, if a theory is in a regime where electric degrees of freedom are strongly coupled the dual theory, in terms of magnetic degrees of freedom, is weakly coupled and vice versa. The coupling constants of the two theories are inversely proportional allowing one to investigate strong coupling aspects of both dual theories. There is still a region however when the coupling is $\mathcal{O}(1)$ where even with the help of this duality nothing definitive can be said. This type of duality is known as a weak-strong duality. Supersymmetric, and in particular, string theories provide many examples of dualities. The strong coupling limits of type II string theory are examples of this. Type IIA at strong string coupling is M theory wrapped on a circle with the string coupling and the radius of the circle are proportional. Thus if one wants information about strongly coupled Type IIA, M theory on a large circle is studied.

In this dissertation certain interesting properties of 4 dimensional $\mathcal{N} = 2$ will be reviewed. $\mathcal{N} = 2$ supersymmetry provides an ideal setting in which to study strong coupling properties of gauge theories. As mentioned above supersymmetry allows for more dualities, thus providing access to strong coupling regions. In addition perturbative quantum effects do not go past one loop for $\mathcal{N} = 2$ supersymmetry due to non-renormalisation theorems [34], giving one the hope of finding analytical solutions. This is in contrast to $\mathcal{N} = 4$ where there are no perturbative quantum corrections (the β function vanishes) and $\mathcal{N} = 0, 1$ higher order corrections play a role. Non perturbative corrections may still be present to complicate the situation but nevertheless one could hope to discover perhaps generic strong coupling behaviour which could help in the understanding in the more realistic realms of $\mathcal{N} = 0, 1$ supersymmetric theories.

Another interesting aspect of supersymmetric gauge theories is that they allow spaces of inequivalent vacua. $\mathcal{N} = 1$ supersymmetry allows for a superpotential in the low energy action which lifts these vacua, more supersymmetry forbids this

superpotential and the space of vacua persists. The aim of this dissertation is to review works studying such moduli spaces of inequivalent vacua. In particular the focus will be on the remarkable equivalence between the moduli space of vacua and the moduli space of families of elliptic or hyperelliptic curves. This equivalence was discovered by Seiberg and Witten in the mid 90s, [1], and led to a large amount of research exploring its implications and extending it to other scenarios [2]-[13]. It became an important technique in the study of $\mathcal{N} = 2$ theories and is still utilised in research being carried out today [27]-[29].

This dissertation is organised as follows. In chapter 2 the topic of Seiberg Witten curve is introduced. The initial work of Seiberg and Witten is reviewed as well as extensions of this to higher rank gauge groups and the inclusion of matter. Chapter 3 uses string theory to provide an intuitive method for construction of SW curves as well as give them a physical interpretation. In chapter 4 the techniques developed in the preceding chapters are used to explore new dualities of $\mathcal{N} = 2$ SCFTs.

2. Seiberg-Witten Gauge Theory

This chapter starts with a review of [1]. The goal of this work was to obtain strong coupling information about $\mathcal{N} = 2$ gauge theories, specifically with gauge group $G = SU(2)$. The amount of supersymmetry present meant that the low energy effective action could be exactly determined using an auxiliary geometric object known as the Seiberg Witten curve. The discovery of the SW curve was the real long lasting accomplishment of this work. Properties of a theory can be deduced by studying its SW curve without having to resort to equations of motion or a Lagrangian, which are often not known. Extensions of this to higher rank gauge groups [3] [4] [5] [7] [8] [9] and the inclusion of matter [2] [10] [11] [12] [13] will also be reviewed.

This new formalism for describing supersymmetric gauge theories led to explanations of previously known phenomena as well as new exotic theories. Charge confinement of pure $\mathcal{N} = 1$ theories was explained via monopole condensation in [1], [6] and explicit constructions of non local theories were found in [7] will be briefly discussed.

2.1 Pure $SU(2)$ Super Yang-Mills

2.1.1 R-symmetries and chiral anomaly

Extended supersymmetry algebras admit global symmetries known as R-symmetries. For the $\mathcal{N} = 2$ algebra this is $SU(2)_R \times U(1)_R$ with the $SU(2)_R$ rotating supercharges of the same chirality into one another and $U(1)_R$ acting on positive chirality supercharges with charge -1 and negative chirality with $+1$.

The two main multiplets of $\mathcal{N} = 2$ supersymmetry are the vector multiplet (here-

after referred to as a V-plet) and hypermultiplet (hyper). The V-plet consists of a gauge field A_μ , complex scalar ϕ and two Weyl fermions λ and ψ . Both A_μ and ϕ are singlets under $SU(2)_R$ while the fermions form a doublet. It can be written in terms of $\mathcal{N} = 1$ multiplets (V, Φ_α) where V is the $\mathcal{N} = 1$ V-plet with field strength W_α and Φ_α the chiral multiplet. (V, Φ_α) transforms in the adjoint representation of the gauge group. The hypermultiplet contains two complex scalars and two weyl fermions. As with the V-plet it can be represented using $\mathcal{N} = 1$ multiplets, by 2 chiral multiplets (Q, \tilde{Q}) . Q and \tilde{Q} transform in conjugate representations of the gauge group. The complex scalars are singlets under $SU(2)_R$ while the fermions again form a doublet.

One can form a Dirac spinor out of the two weyl fermions in both of these multiplets. The Abelian part of the R-symmetry then acts as $e^{i\alpha\gamma_5}$ on these Dirac fermions i.e. as a chiral symmetry. Thus the classical $U(1)_R$ is broken to a discrete subgroup by the chiral anomaly. To find the subgroup one first requires the notion instantons of fermion zero modes.

Any non abelian gauge theory contains solitonic solutions known as instantons. These are non perturbative finite energy solutions of the gauge field. They have a moduli space of inequivalent solutions parametrised by a set of collective coordinates. A particular type of collective coordinate called fermion zero modes will be needed here. These are zero energy deformations of the instanton solution due fermions coupled to the gauge group. Each left handed fermion in the adjoint rep contributes $2N_c$ zero modes and only a single zero mode if it is in the fundamental or anti fundamental. For a correlator to be non-zero in an instanton background requires extra fermion terms (one per zero mode) to be included in order to absorb these zero modes. The first non zero correlator is

$$G^{(4N_c-2N_f)} = \langle \lambda(x_1) \dots \lambda(x_{2N_c}) \psi(y_1) \dots \psi(y_{2N_c}) \psi_q(z_1) \dots \psi_q(z_{N_f}) \tilde{\psi}_q(u_1) \dots \tilde{\psi}_q(u_{N_f}) \rangle \quad (2.1)$$

Under $U(1)_R$, $G^{(4N_c-2N_f)} \rightarrow e^{i\alpha(4N_c-2N_f)} G^{(4N_c-2N_f)}$. Thus $U(1)_R \rightarrow \mathbb{Z}_{4N_c-2N_f}$. The global symmetry is, however, not the product of this with $SU(2)_R$. The Weyl group element of $SU(2)$, \mathbb{Z}_2 is already contained in $\mathbb{Z}_{4N_c-2N_f}$. Therefore to avoid double

counting this, the global symmetry is

$$\frac{SU(2)_R \times \mathbb{Z}_{4N_c - 2N_f}}{\mathbb{Z}_2} \quad (2.2)$$

2.1.2 Moduli Space

The action of a pure $\mathcal{N} = 2$ gauge theory is

$$S = \int d^4x \left[\text{Im} \left(\frac{\tau}{16\pi^2} d^2\theta \text{Tr} W_\alpha W^\alpha \right) + \frac{1}{4g^2} \int d^4\theta \text{Tr} \Phi^+ e^{-2gV} \Phi \right] \quad (2.3)$$

The scalar potential is $V \propto \text{Tr}[\phi, \phi^+]^2$. This is minimised if ϕ is an element of the Cartan subalgebra of $SU(2)$. For $SU(2)$ pick $\langle \phi \rangle = \text{diag} \frac{1}{2}(a, -a)$. A non zero value for a will break the \mathbb{Z}_8 R-symmetry to \mathbb{Z}_4 (as it has charge 2 under the anomalous R-symmetry). The Weyl transformation of the $SU(2)$ gauge group acts $a \rightarrow -a$ so use

$$u = \frac{1}{2}a^2 = \langle \text{Tr} \phi^2 \rangle \quad (2.4)$$

to parametrise the moduli space, \mathcal{M} , of inequivalent vacua. $U(1)_R$ acts as \mathbb{Z}_2 on u . For higher rank gauge groups the Weyl group $W_{SU(N_c)} \not\subset \mathbb{Z}_{4N_c - 2N_f}$ except at special submanifolds so the moduli space has a \mathbb{Z}_{2N_c} symmetry. At a generic point in the moduli space the gauge group is broken to $U(1)$ and W^\pm bosons become massive. Classically there is a singularity at the origin of the moduli space where the gauge group is enhanced to $SU(2)$ and W^\pm become massless again.

2.1.3 Low energy Action

To make the analysis of the full quantum theory more tractable only the low energy theory is studied. In the Wilsonian approach to obtaining a low energy theory all states above a certain renormalisation scale, μ , are integrated out. The full theory is asymptotically free with dynamically generated scale Λ , if the renormalisation scale is chosen to be much larger than a , the symmetry breaking scale, then the masses of W^\pm are negligible and the asymptotic freedom persists. If however the scale is below

a , W^\pm will be integrated out and the low energy is $U(1)$ gauge theory which flows to zero coupling. In the following $\mu = a$.

The Wilsonian low energy action is determined in terms of a holomorphic function of the V-plet, $\mathcal{F}(A)$, called the prepotential. The massive W^\pm bosons are integrated out and the action is

$$S = \frac{1}{4\pi} \int d^4x \text{Im} \left[\int d^4\theta \mathcal{F}'(A) A^+ + \frac{1}{2} \int d^2\theta \mathcal{F}''(A) W^\alpha W_\alpha \right] \quad (2.5)$$

The second derivative of the prepotential is the coefficient of the gauge kinetic term. As such it plays the role of the gauge coupling in the low energy theory, $\tau(a) = \frac{\theta}{2\pi} + \frac{4\pi i}{g^2(a)}$. The coupling is now a function of a , which sets the scale of the theory. No superpotential can be added to this and preserve the $\mathcal{N} = 2$ supersymmetry, therefore the vacuum degeneracy is not lifted by quantum effects. The topology of the moduli space is changed however. It is a Kahler manifold with Kahler potential

$$K = \text{Im} \left(\mathcal{F}'(A) A^+ \right) \quad (2.6)$$

whose metric is $ds^2 = \text{Im} \mathcal{F}''(a) da da^* = \text{Im} \tau(a) da da^*$. Classically $\mathcal{F}(A) = 1/2\tau_{cl} A^2$ where τ_{cl} is the classical gauge coupling. This receives quantum corrections, perturbatively at one loop level but also from non perturbative effects as well. The perturbative correction is found by integrating the one loop β function expression $a \frac{dg}{da} = \frac{-b_0}{16\pi^2} g^3$, $b_0 = 2N_c - N_f$. The non perturbative corrections are due to instantons. The action for a k -instanton is

$$e^{-8\pi^2 k/g^2} = \left(\frac{\Lambda}{a} \right)^{4k} \quad (2.7)$$

where the right hand side is due to the β function. Upon integrating these one gets

$$\mathcal{F}_{1-loop}(A) = \frac{i}{2\pi} A^2 \ln \frac{A^2}{\Lambda^2}, \quad \mathcal{F}_{np}(A) = \sum_{n=1}^{\infty} a_n \left(\frac{\Lambda}{A} \right)^{4n} A^2 \quad (2.8)$$

2.1.4 Duality

For the metric on the Kahler manifold to be well defined $\text{Im } \tau(a)$ must be positive definite. At large a non perturbative effects can be discounted and 2.8 differentiated

$$\tau(a) = \frac{i}{\pi} \left(\ln \left(\frac{a^2}{\Lambda^2} \right) + 3 \right) \quad (2.9)$$

This is a multivalued function with positive definite imaginary part. If $\tau(a)$ were globally defined it would be harmonic and so have no minimum. This would contradict the positive definiteness. $\tau(a)$ is therefore not globally defined and new variables are required to make it so. One could also note that the non perturbative effects become increasingly more dominant as a gets smaller, in particular the instanton sum will no longer converge. It can be made to converge by re-summing in new ‘magnetic’ variables. Write

$$ds^2 = \text{Im} da_D da^* = \frac{-i}{2} (da_D da^* - da da_D^*) \quad (2.10)$$

where $a_D = \mathcal{F}'(a)$ is a locally good parameter. Changing from a to a_D is essentially electric-magnetic duality. In terms of any other parameter

$$ds^2 = \frac{-i}{2} \varepsilon_{\alpha\beta} \frac{da^\alpha}{du} \frac{da^{*\beta}}{du^*} du du^*, \quad a^\alpha = (a_D, a) \quad (2.11)$$

This is invariant under an $Sp(2) \simeq SL(2, \mathbb{R})$ rotation of a^α (this will later be reduced to $SL(2, \mathbb{Z})$) and also under addition of a constant i.e. under $\underline{a} \rightarrow M\underline{a} + c$. $SL(2, \mathbb{R})$ is generated by

$$T_b = \begin{pmatrix} 1 & b \\ 0 & 1 \end{pmatrix} \quad S = \begin{pmatrix} 0 & 1 \\ -1 & 0 \end{pmatrix} \quad b \in \mathbb{R} \quad (2.12)$$

$T_b : a_D \rightarrow a_D + ba$ but as $a_D = \mathcal{F}'(a)$, under T_b $\tau(a)$ shifts by b . This corresponds to a shift in the θ parameter of the theory by $2\pi b$ and so is a symmetry only if $b \in \mathbb{Z}$. This reduces the duality group to $SL(2, \mathbb{Z})$. S acts by $a_D \rightarrow a$, which seems to imply that S implements a form of electric-magnetic duality. To confirm this suspicion, study the action of S on the gauge fields.

The usual method of implementing a duality transformation on a Lagrangian is

to introduce a Lagrange multiplier. Starting first with $\mathcal{N} = 1$ fields and the gauge kinetic term

$$\frac{1}{8\pi} \text{Im} \int d^4x d^2\theta \tau(A) W^2 \quad (2.13)$$

Taking W_α as the independent field, the Bianchi identity, $\text{Im} \mathcal{D}W = 0$ is enforced by adding to 2.13

$$\frac{1}{4\pi} \text{Im} \int d^4x d^2\theta V_D \mathcal{D}W = \frac{1}{4\pi} \text{Re} \int d^4x d^2\theta i \mathcal{D}V_D W = -\frac{1}{4\pi} \text{Im} \int d^4x d^2\theta W_D W \quad (2.14)$$

with V_D , an $\mathcal{N} = 1$ V-plet, the Lagrange multiplier and $\mathcal{D}V_D = W_D$. Completing the square and then performing the Gaussian integral one arrives at the dual action

$$\frac{1}{8\pi} \text{Im} \int d^4x d^2\theta \frac{-1}{\tau(A)} W_D^2 \quad (2.15)$$

Doing the same for $\mathcal{N} = 2$ requires a transformation $A \rightarrow A_D$ as it appears explicitly in 2.3 rather than just through the gauge kinetic term. After making the following definitions $\mathcal{F}' = h$ (which $\Rightarrow h' = \tau$), $A_D = h(A)$ and h_D as minus the inverse function of h , $h_D \circ h = -\text{id}$ then

$$\text{Im} (\mathcal{F}'(A) A^+) = \text{Im} (h(A) A^+) = \text{Im} (A_D (-h_D(A))^*) = \text{Im} (h_D(A_D) A_D^+) \quad (2.16)$$

The last equality comes from the fact that the imaginary part of a complex number is minus the imaginary part of its complex conjugate. By differentiating $h_D \circ h = -\text{id}$ one comes to

$$\frac{-1}{\tau(A)} = \frac{-1}{h'(A)} = h'_D(A_D) \equiv \tau_D(A_D) \quad (2.17)$$

With this, the dual Lagrangian is actually seen to be the same as 2.5 except that all the fields are instead dual ‘magnetic’ fields, labelled by the subscript D . Now we come to the point of all this. The duality sends $A_D \rightarrow A$ and $A \rightarrow -A_D$ and thus is actually S . The action of S on τ

$$\tau(A) \rightarrow \tau_D(A_D) = \frac{-1}{\tau(A)} \quad (2.18)$$

justifies the labelling of this $SL(2, \mathbb{Z})$ transformation as an electric-magnetic duality.

Therefore we have that the moduli space is parametrised by the gauge invariant quantity u . a_D, a are functions of this and provide good local coordinates in different regions. a is appropriate at large u and the relationship between the two is given by 2.4. As one moves towards strong coupling a duality transformation can be performed, after which the theory is weakly coupled in these new fields, for instance it will soon be shown that there is a strong coupling point at $u = \Lambda^2$. In the region of this point $a_D(u)$ is a good local coordinate. The dual theory in this region is a weakly coupled $U(1)$ theory with fields A_D .

2.1.5 Central Charge and BPS States

Another aspect of extended supersymmetry is the appearance of a central charge, Z , in the superalgebra. The central charge is an operator that commutes with all elements of the algebra. It modifies the commutators so that $\{Q_\alpha^I, Q_\beta^J\} = 2\sqrt{2}\varepsilon_{\alpha\beta}Z^{IJ}$. The Clifford algebra formed from this is defined by $\{a_\alpha, a_\beta^\dagger\} = \delta_{\alpha\beta}(M + \sqrt{2}Z)$, $\{b_\alpha, b_\beta^\dagger\} = \delta_{\alpha\beta}(M - \sqrt{2}Z)$. These imply a lower bound for the mass of a state $M \geq \sqrt{2}|Z|$. If $M = \sqrt{2}|Z|$ one of these commutators will vanish and the state will be in a short representation of the superalgebra (4 polarisation modes instead of the usual 16 for a massive rep). States of this kind are known as BPS.

Classically the central charge is $Z_{cl} = a(n_e + \tau_{cl}n_m)$. Here the charges n_e, n_m are normalised as follows; particles in reps of $SO(3)$, gauge bosons for example, have $n_e \in \mathbb{Z}$ while particles in $SU(2)$ reps, fundamental hypers, have $n_e \in \mathbb{Z}/2$. At present no hypers will be considered but later when they are, a redefinition of the coupling will be used to ensure all particles have integer charge.

The central charge is modified quantum mechanically. To see why, consider coupling a single BPS hyper (Q, \tilde{Q}) to the gauge theory. The terms that couple the hyper to the V-plet are

$$\sqrt{2}n_e A Q \tilde{Q}, \quad \sqrt{2}n_m A_D Q \tilde{Q} \tag{2.19}$$

The mass for the hyper is given by the scalar component of the V-plet. Thus

$$Z = n_m a_D + n_e a \quad (2.20)$$

In the classical limit $a_D = \mathcal{F}'_{cl} = \tau a$ and Z_{cl} is recovered. As $\sqrt{2}Z$ is the mass of this coupled hyper it should be invariant under the duality transformation. $(a_D, a) \rightarrow M(a_D, a) \Rightarrow (n_m, n_e) \rightarrow (n_m, n_e)M^{-1}$. If $(a_D, a) \rightarrow M(a_D, a) + c$ the addition of c cannot be compensated for, so $c = 0$.

BPS states are protected from decay to non-BPS states as that would require a jump from a short rep to long rep. There are not enough degrees of freedom, however, to facilitate this. This property is also true in the quantum theory. While they cannot decay to non-BPS particles, under certain circumstances they can decay to other BPS states. A state with central charge $Z = n_m a_D + n_e a$ can decay to several with $Z_i = n_m^i a_D + n_e^i a$ if charge is conserved, $(n_m, n_e) = \sum_i (n_m^i, n_e^i)$. By the triangle inequality

$$|Z| \leq \sum_i |Z_i| \Rightarrow M \leq \sum_i M_i \quad (2.21)$$

Hence decay is possible when there is equality in 2.21. This requires that Z_i and Z be aligned, $a_D/a \in \mathbb{R}$. If a state has charge (n_m, n_e) with n_m, n_e mutually prime and $a_D/a \notin \mathbb{R}$ then it is stable against decay, if the theory enters a region of the moduli space where $a_D/a \in \mathbb{R}$ it is then susceptible to decay and will no longer exist in the BPS spectrum even if the theory re-enters $a_D/a \notin \mathbb{R}$.

2.1.6 Monodromies

From 2.9 one can see that the regime of weak coupling is associated to large a . Perturbative effects dominate here and

$$a_D = \frac{2ia}{\pi} \ln \frac{a}{\Lambda} + \frac{ia}{\pi} \quad (2.22)$$

a_D is therefore a multivalued function in this region. It indicates a singularity with a non trivial monodromy at large a in the moduli space, the complex u plane. The

monodromy should be an element of $SL(2, \mathbb{Z})$. To get its exact form send $u \rightarrow e^{2\pi i}$ which, at weak coupling causes $a \rightarrow e^{\pi i} a = -a$ and

$$a_D \rightarrow \frac{2ie^{\pi i} a}{\pi} \ln \frac{e^{\pi i} a}{\Lambda} - i \frac{a}{\pi} = -a_D + 2a \quad (2.23)$$

The monodromy matrix, M_∞ , for this weak coupling singularity is then

$$M_\infty = PT^{-2} = \begin{pmatrix} -1 & 2 \\ 0 & -1 \end{pmatrix}, \quad P = -\text{id}, \quad T = \begin{pmatrix} 1 & 1 \\ 0 & 1 \end{pmatrix} \quad (2.24)$$

P is present in the classical system, it is just the Weyl transformation $a \rightarrow -a$, $a_D \rightarrow -a_D$. It arises because a path from a to $-a$ is actually a closed path in the u plane. Physically it reverses the sign of the EM charges. The part T^{-2} arises only in the quantum theory and is due to the logarithm in 2.22.

Each monodromy is associated to a non-trivial closed path in the moduli space e.g. M_∞ is associated to any path that loops about the singularity at infinity. Monodromies are therefore a representation of the fundamental group of the space \mathcal{M}' , $\pi_1(\mathcal{M}')$. Where \mathcal{M}' is the moduli space with any singularities replaced by punctures. Were $\pi_1(\mathcal{M}')$ to be abelian, all the monodromies would commute. Consequently a would be a good coordinate everywhere on \mathcal{M} . This is not the case however, so $\pi_1(\mathcal{M}')$ is non abelian and there must be at least two other singularities, related by the \mathbb{Z}_2 symmetry of \mathcal{M} with associated non commuting monodromies. These singularities are at finite values of u and are called strong coupling singularities.

Usually a singularity in a moduli space corresponds to some degrees of freedom becoming massless and a breakdown in the ability of 2.5 to describe the theory. Assuming that is the case here, one can ask what are these new massless degrees of freedom. In the classical theory the singularity at $u, a, a_D = 0$ indicated the W^\pm bosons becoming massless. In the full quantum theory, strong coupling singularities are not due to massless bosons, but rather massless monopoles and dyons. Massless bosons would imply the existence of a $U(1)_{\mathcal{R}}$ current which is not present.

If one assumes it is a monopole becoming massless then it will do so at the point

u_0 , 2.20, where $a_D(u_0) = 0$. Near this point $a_D = c(u - u_0)$ is a good coordinate. The low energy theory is a $U(1)$ gauge theory and about u_0 have

$$\tau_D \cong \frac{-i}{\pi} \ln \frac{a_D}{\Lambda} \quad (2.25)$$

The definition of h_D implies that $a(u) = -h_D(u)$ and combined with the definition of τ_D , 2.17 gives

$$a(u) = a_0 + \frac{i}{\pi} a_D \ln \frac{a_D}{\Lambda} \quad (2.26)$$

where a_0 is a non zero constant. The monodromy about this point is obtained by $u \rightarrow e^{2\pi i} u$ which results in $a_D \rightarrow a_D$ and

$$a \rightarrow a_0 + \frac{i}{\pi} (u - u_0) \left(\ln \frac{(u - u_0)}{\Lambda} + 2\pi i \right) = a - 2a_D \quad (2.27)$$

the monodromy matrix, M_{u_0} is

$$M_{u_0} = ST^2S = \begin{pmatrix} 1 & 0 \\ -2 & 1 \end{pmatrix} \quad (2.28)$$

To obtain the monodromy at the other strong coupling point $-u_0$ one simply notes that by a contour deformation

$$M_\infty = M_{u_0} M_{-u_0} \quad (2.29)$$

Which can be solved to give

$$M_{-u_0} = \begin{pmatrix} -1 & 2 \\ -2 & 3 \end{pmatrix} \quad (2.30)$$

This singularity should also correspond to a state becoming. The charges of this state should be invariant under the monodromy implying that $\underline{n} = (n_m, n_e)$, is the left eigenvector of M_{-u_0} . Therefore a dyon of charge $(1, -1)$ becomes massless at the third singularity. The two strong coupling singularities are located at $u = \pm\Lambda^2$

2.1.7 Seiberg Witten curve

The analysis of the previous sections has provided the following description of the moduli space. \mathcal{M} is the complex u plane endowed with a \mathbb{Z}_2 symmetry, $u \rightarrow -u$ and three singularities at $u = \pm\Lambda^2, \infty$. The monodromies about these singularities generate $\Gamma(2)$, meaning that $\pi_1(\mathcal{M}') = \Gamma(2)$. This is a description of the space $\mathbb{H}/\Gamma(2)$ where \mathbb{H} is the upper half plane, therefore

$$\mathcal{M} \cong \mathbb{H}/\Gamma(2) \tag{2.31}$$

Now comes the crux of the argument, $\mathbb{H}/\Gamma(2)$ is also the moduli space a family of elliptic curves defined by the equation

$$y^2 = (x - \Lambda^2)(x + \Lambda^2)(x - u) \tag{2.32}$$

This equation describes a two sheeted cover of the x plane, branched at the points $x = \pm\Lambda^2, u, \infty$ and also is the defining equation for a genus 1 Riemann surface, Σ_u . One can confirm this using the Riemann-Hurwitz formula, which relates the number of branch points to the genus,

$$g(\Sigma_u) - 1 = -\deg(\pi) + \frac{1}{2}b \tag{2.33}$$

π is the projection of the surface to the x plane, it has degree 2 and b is the branching index, for the cases considered this is simply the number of branch points. This gives $g(\Sigma) = 1$.

Thus \mathcal{M} is both the moduli space of an $SU(2)$ gauge theory and also of a family of genus 1 Riemann surfaces. As one moves around the moduli space the nature of the gauge theory changes, e.g. if u is large the theory is weakly coupled. Likewise the shape of the Riemann surface changes as u varies, in particular if any two of the branch points collide the Riemann surface degenerates e.g. as $u \rightarrow \pm\Lambda^2$ a cycle of the surface shrinks to zero size.

The coordinates a, a_D are functions of u and transform under $SL(2, \mathbb{Z})$, they are

thus sections of an $SL(2, \mathbb{Z})$ bundle over the complex u plane. Such a bundle also exists on the geometry side of this relationship. The first cohomology group of Σ_u , $H^1(\Sigma_u, \mathbb{C})$ are fibres of an $SL(2, \mathbb{Z})$ bundle over \mathcal{M} . The two independent cycles of Σ_u γ, γ_D are such that γ encircles the cut from Λ^2 to $-\Lambda^2$ while γ_D encircles the branch points at $u = \Lambda^2$ and u crossing bot cuts in the process. Having done this a, a_D are defined to be

$$a = \int_{\gamma} \lambda, \quad a_D = \int_{\gamma_D} \lambda \quad (2.34)$$

where λ is a meromorphic one form on Σ_u and as such can be expanded in the basis of one forms

$$\lambda = g_1(u)\lambda_1 + g_2(u)\lambda_2, \quad \lambda_1 = \frac{dx}{y}, \quad \lambda_2 = \frac{x dx}{y} \quad (2.35)$$

Deforming the cycles by an $SL(2, \mathbb{Z})$ transformation corresponds to a duality transformation on a, a_D . If the cycles are deformed across a pole of λ , a or a_D would be shifted by a constant proportional to the residue of λ there. It has already been argued that such shifts are not allowed hence λ should actually be holomorphic.

A geometric interpretation for $\tau(u)$ is still required. Recall that it is defined by $\tau = da_D/da$ and has the property that $\text{Im}\tau(u) > 0$. The complex parameter of the Riemann surface, τ_u also has this property. It is defined to be

$$\tau_u = \frac{\omega_2}{\omega_1} \quad (2.36)$$

where

$$\omega_2 = \int_{\gamma_D} \lambda_1, \quad \omega_1 = \int_{\gamma} \lambda_1 \quad (2.37)$$

$\tau(u)$ and τ_u can be equated if λ satisfies certain conditions

$$\tau(u) = \frac{da_D}{da} = \frac{da_D}{du} / \frac{da}{du} = \frac{\omega_2}{\omega_1} \quad \text{if} \quad \frac{\partial \lambda}{\partial u} = f(u)\lambda \quad (2.38)$$

up to an exact form, the addition of which would not affect 2.34. The differential

equation for λ can be integrated giving

$$\lambda = \frac{\sqrt{2}}{2\pi} \frac{y dx}{x^2 - 1} \quad (2.39)$$

inserting this into 2.34 the monodromies about the different singularities can be confirmed to agree with those computed on the gauge theory side. This serves as a consistency check of the proposed equivalence, such a check will be left to the next section where higher rank gauge groups will be considered.

Equipped with this equivalence between the Coulomb branch of a gauge theory and a Riemann surface one can interpret the behaviour of one in terms of the other. At the strong coupling singularities, $u \rightarrow \pm\Lambda^2$ either a monopole or dyon becomes massless. In this region the validity of 2.5 shrinks to zero, the new massless degrees of freedom must be included in the Lagrangian in the form of a hyper coupled to the gauge theory. In terms of the weak coupling field A the theory is strongly coupled. Duality allows us to make a transformation to ‘magnetic’ variables in which the dual theory is weakly coupled and the massless hyper is ‘electrically’ coupled to these new fields. The same duality transformation takes the weak coupling coordinate a to local coordinate in this region. For example in the region of $u = \Lambda^2$, a_D is a good coordinate, A_D is the weakly coupled field and the singularity corresponds to $a_D = 0$

The same point in the moduli space corresponds to the degeneration of the Riemann surface. One of γ, γ_D or a linear combination of them shrinks to zero size. Using 2.34 one sees that either a, a_D or a linear combination of them also vanishes. For example at $u = \Lambda^2$ the branch points at $x = u, \Lambda^2$ have collided thus causing γ_D to shrink and forcing $a_D = 0$. At $u = -\Lambda^2$ the cycle $\gamma_D - \gamma$ has shrunk meaning $a_D - a = 0$

Every shrinking cycle of the Riemann surface corresponds to a BPS state becoming massless. Indeed the central charge is

$$Z = n_m a_D + n_e a = \int_{n_m \cdot \gamma_D + n_e \cdot \gamma} \lambda \quad (2.40)$$

To every linear combination of γ, γ_D one can associate a BPS state.

2.1.8 Monopole Condensation

One can break the supersymmetry to $\mathcal{N} = 1$ via the addition of a superpotential of the form $\mathcal{W} = m\text{Tr}\Phi^2$ which gives a mass, m , to the chiral superfield part of the V-plet. At low enough energies this will be integrated leaving a pure $\mathcal{N} = 1$ gauge theory. Such a theory is known to have a mass gap, after breaking in this fashion however it does not seem to. To produce the expected behaviour requires some light fields that can be used to Higgs the gauge field. Fortunately, such fields do exist at the strong coupling singularities.

For low mass $\text{Tr}\Phi^2$ appears in the low energy action as mU , where U is a chiral superfield with scalar component u . In a region near where a monopole becomes massless the superpotential is given by

$$\mathcal{W} = \sqrt{2}A_D M \tilde{M} + mU \quad (2.41)$$

With the local coordinate being a_D . Denoting the scalar components of the monopole hyper by (M, \tilde{M}) one gets that

$$\sqrt{2}A_D M \tilde{M} + m \frac{du}{da_D} = 0 \quad (2.42)$$

$$a_D M = a_D \tilde{M} = 0 \quad (2.43)$$

When $m = 0$ this reduces to the usual $\mathcal{N} = 2$ vacua with $|M| = |\tilde{M}| = 0$. For non zero mass however the solution is $a_D = 0$,

$$M = \tilde{M} = \left(-\frac{m}{\sqrt{2}} \frac{du}{da_D} \Big|_{a_D=0} \right)^{1/2} \quad (2.44)$$

Thus in this the only vacuum that survives is the strong coupling singularity. The gauge field acquires a mass through the Higgs mechanism and the theory has a mass gap. This Higgs mechanism is different from the usual form, in that it involves the condensation of monopoles this leads to confinement of electric charge in the $\mathcal{N} = 1$ theory.

In the regular Higgs mechanism there is a condensate of electric charges which causes the screening of any background electric field. All magnetic field lines are excluded (Meissner effect) meaning that flux tubes must form and magnetic charge is confined. In the present situation there is confinement of electric charge due to a dual Meissner effect.

In the region of the other strong coupling singularity a similar process occurs. Therefore the two strong coupling singularities are the only $\mathcal{N} = 1$ vacua. When $G = SU(N)$ is considered the same behaviour can be seen. There are N points where $N - 1$ dyons become massless, these points are the $\mathcal{N} = 1$ vacua.

2.2 SU(N)

For an $SU(N)$ $\mathcal{N} = 2$ gauge theory the moduli space of inequivalent vacua is obtained by minimising the scalar potential $V \propto \text{Tr}[\phi, \phi^\dagger]^2$ which means that

$$\langle \phi \rangle = \sum_{i=1}^N a_i H^i, \quad \text{with} \quad \sum_{i=1}^N a_i = 0 \quad (2.45)$$

where H^i are elements of the Cartan subalgebra of $U(N)$, $\sum_{i=1}^N a_i = 0$ restricts $\langle \phi \rangle$ to be in the Cartan of $SU(N)$ instead. Thus the classical moduli space is

$$\mathcal{M}_N^{\text{cl}} = \frac{\mathcal{T}_N}{S_N} \quad (2.46)$$

$\mathcal{T}_N = \{a_i | a_i \in \mathbb{C}, \sum_{i=1}^N a_i = 0\}$ and S_N the permutation group of N objects, is the Weyl group of $SU(N)$. Generically a non zero value for $\langle \phi \rangle$ will break $SU(N) \rightarrow U(1)^{N-1}$. There are special submanifolds where the a_i coincide and S_N does not act freely. Along these submanifolds the gauge symmetry is not completely broken but enjoys an enhancement to some non abelian subgroup, in particular when all a_i coincide, $a_i = 0 \forall i$ and $SU(N)$ is unbroken.

The W_{ij}^\pm bosons gain masses $\propto |a_i - a_j|$ and will be integrated out when the low

energy theory is considered. The low energy action is

$$S_{eff} = \frac{1}{4\pi} \int d^4x \operatorname{Im} \left[\int d^4\theta A_D^i A_i^+ + \frac{1}{2} \int d^2\theta \tau^{ij} W_i^\alpha W_{j\alpha} \right] \quad (2.47)$$

where $A_D^i = \partial^i \mathcal{F}$ and $\tau^{ij} = \partial^i \partial^j \mathcal{F}$, \mathcal{F} being the prepotential. The duality group is $Sp(N-1, \mathbb{Z})$, it acts on $\underline{A} = (A_D^i, A^i)$ by $\underline{A} \rightarrow M \underline{A}$ and on τ^{ij} by

$$\tau^{ij} \rightarrow \frac{A\tau + B}{C\tau + D}, \quad M = \begin{pmatrix} A & B \\ C & D \end{pmatrix} \quad (2.48)$$

A, B, C, D are $(N-1) \times (N-1)$ matrices.

The chiral anomaly breaks $U(1)_{\mathcal{R}} \rightarrow \mathbb{Z}_{4N}$. ϕ has charge 2 under this meaning that \mathcal{T}_N has a \mathbb{Z}_{2N} symmetry $a_i \rightarrow e^{\frac{i\pi}{N}} a_i$. To parametrise \mathcal{M}_N use the gauge invariant coordinates

$$u_k = \langle \operatorname{Tr} \phi^k \rangle = \sum_i a_i^k \quad (2.49)$$

The \mathbb{Z}_{2N} symmetry acts $u_k \rightarrow e^{\frac{i\pi k}{N}} u_k$. One could also use the elementary symmetric polynomials

$$s_k = (-1)^k \sum_{i_1 < \dots < i_k} a_{i_1} \dots a_{i_k} \quad (2.50)$$

which are related to the u_k s by

$$k s_k + \sum_l s_{k-l} u_l = 0, \quad s_0 = 1, s_1 = 0, u_0 = 0, u_1 = 0 \quad (2.51)$$

2.2.1 SW Curve

We now attempt to find the curve which describes the Coulomb branch physics of an $SU(N)$ gauge theory. Following the previous section, the gauge couplings τ^{ij} should be equated with the period matrix of the Riemann surface described by the SW curve and $a_i, a_D^i, i = 1, \dots, N-1$ with periods of a holomorphic differential λ . Thus one concludes that the SW curve describes a genus $N-1$ surface. To start, consider the

hyperelliptic curve

$$y^2 = \prod_{l=1}^{2N} (x - e_l) = F(x) \quad (2.52)$$

This is a two sheeted covering of the x plane branched at $2N$ points, e_l . Using the Riemann-Hurwitz formula one sees that 2.52 describes a genus $N - 1$ surface. A curve $y^2 = F$ with F degree $2N - 1$ in x will also describe a genus $N - 1$ surface but requires a branch point at infinity. This is the form of the curve derived in the preceding section for $SU(2)$. Having all the branch points at finite values, however, will make the analysis of the monodromies much easier.

The coefficients of F must be gauge invariant parameters, u_k or s_k , and/or Λ the dynamically generated scale of the theory. When $\Lambda \rightarrow 0$ or equivalently $|a_i - a_j| \gg \Lambda$ the curve should reproduce the properties of the gauge theory at weak coupling. The curve should be singular along the special submanifolds where the gauge symmetry is enhanced; the branch points collide when the a_i s coincide. Thus as $\Lambda \rightarrow 0$, $F(x)$ contains a factor $P(x) = \prod_{i=1}^N (x - a_i)$. In addition at weak coupling there is an ever present singularity which does not depend on the specific values of a_i . Such a singularity occurred in the $SU(2)$ case, physically it comes from the logarithm in the equation for the coupling 2.62 and also from the fact that paths that are closed in \mathcal{M}_n may only be closed in \mathcal{T}_N up to a Weyl group transformation (c.f. 2.24). This behaviour is reproduced in the curve if at weak coupling every root of the right hand side of 2.52 is a double root i.e. $y^2 = P(x)^2$.

As one moves towards weak coupling instanton effects become more important. This can be reflected in the curve by the emergence of terms proportional to the one instanton amplitude. All these elements combined, lead to the following proposal for the SW curve

$$y^2 = P(x)^2 - \Lambda^{2N} = \left(\sum_{k=0}^N s_k x^{N-k} \right)^2 - \Lambda^{2N} \quad (2.53)$$

It will be shown in subsequent sections that this curve reproduces the correct monodromies observed of the gauge theory. This can be interpreted as two copies of the classical curve, $P(x)$, which at weak coupling lie atop one another but a stronger

coupling are separated by a distance of $2\Lambda^N$ in the s_N direction. By assigning R charges N to y and 1 to x the curve exhibits the same \mathbb{Z}_{2N} symmetry as the moduli space. This can be restored to the full $U(1)_{\mathcal{R}}$ by further assigning Λ charge 1 .

2.2.2 Weak Coupling Monodromies

One can always break $SU(N) \rightarrow SU(N-1)$ by choosing v.e.v.s of the $SU(N)$ theory appropriately. Therefore a copy of \mathcal{M}_{N-1} should be contained in \mathcal{M}_N , at least at weak coupling. The SW curve encodes this and can be checked by letting $a_i \sim a$, $i = 1, \dots, N-1$ and $a_N = (1-N)a$ with $|a| \gg \Lambda$. After this the curves is

$$y^2 = \prod_i^N (x - a_i)^2 - \Lambda^{2N} = (x - a)^{2(N-1)}(x - (1-N)a)^2 - \Lambda^{2N} \quad (2.54)$$

a shift of $x \rightarrow x + a$ gives

$$x^{2(N-1)}(x + Na)^2 - \Lambda^{2N} \quad (2.55)$$

There are now $2N$ branch points clustered near the origin and a pair near $x = -Na$. By sending this pair off to infinity, the curve for $SU(N-1)$ should be reproduced. Doing this in a consistent fashion requires holding $\frac{\Lambda^{2N}}{a^2} = \Lambda_{N-1}^{2(N-1)}$ fixed. This is the standard renormalisation group matching, it occurs because when one integrates out a color the couplings should run into each other, implying $\left(\frac{\Lambda}{a}\right)^{2N} = \left(\frac{\Lambda_{N-1}}{a}\right)^{2N-2}$. By rescaling $y \rightarrow y(x + Na)$ and then taking the limit, the $SU(N-1)$ curve is produced.

Having checked this, it is now possible to confirm that the weak coupling monodromies are correctly reproduced. As already discussed each weak coupling monodromy is related to an action of the Weyl group, closed paths in \mathcal{M}_N may be only closed in \mathcal{T}_N up to the action of S_N . Thus there are multiple weak coupling monodromies for higher rank groups. It has just been checked that at weak coupling there is a copy of \mathcal{M}_{N-1} . Hence all that needs to be checked is that the single monodromy present in \mathcal{M}_N but not in \mathcal{M}_{N-1} is correctly reproduced. An inductive argument then ensures that the others are present as well. The element of the Weyl group associated

to this is $\pi \in S_N$, $\pi = (123 \dots N)$ which permutes all the a_i s. This element is not related to any region of enhanced gauge symmetry, as opposed to, say, $\pi' = (23 \dots N)$ which corresponds to a region where $SU(N) \rightarrow SU(N-1)$.

First the monodromy will be computed using the SW curve and then checked against results from perturbation theory. It can be computed by following a path in \mathcal{M}_N which is only closed in \mathcal{T}_N up to the action of π . Let $a_J = \omega^J a = e^{\frac{2\pi i J}{N}} a$, which causes $s_k = 0, \forall k \neq N$. The appropriate path is then $a_J(t) = \omega^{J+t} a$, $0 \leq t \leq 1$, $s_N \rightarrow e^{2\pi i} s_N$. With $s_k = 0, \forall k \neq N$ 2.53 becomes

$$y^2 = (x^N + s_N)^2 - \Lambda^{2N} = x^{2N} + s_N^2 \left(1 - \frac{\Lambda^{2N}}{s_N^2}\right) + 2s_N x^N \quad (2.56)$$

$$= \left[x^N + s_N \left(1 - \frac{\Lambda^N}{s_N}\right) \right] \left[x^N + s_N \left(1 + \frac{\Lambda^N}{s_N}\right) \right] \quad (2.57)$$

As this is weak coupling $s_N \gg \Lambda^N$ and the curve factorises

$$y^2 = \prod_{J=1}^N \left(x + \omega^J s_N^{1/N} \left(1 - \frac{\Lambda^N}{s_N}\right) \right) \left(x + \omega^J s_N^{1/N} \left(1 + \frac{\Lambda^N}{s_N}\right) \right) \quad (2.58)$$

The branch points are arranged in N pairs labelled by J at $-\omega^J s_N^{1/N} \left(1 \pm \frac{\Lambda^N}{s_N}\right)$, with cycles of the surface labelled as in figure 2.2.2 (by contour deformation $\sum_i \gamma_i = 0$, this is the same condition as $\sum_i a_i = 0$). Under $s_N \rightarrow e^{2\pi i} s_N$ the J^{th} pair moves to the position of the $J+1^{\text{th}}$ pair. Each pair also performs a full counter clockwise rotation about its centre in the process. The effect of this is to send the cycles $\gamma_i \rightarrow \gamma_{i+1}$ or $\gamma_i \rightarrow P_i^j \gamma_j$ where $P_i^j = \delta_i^j - \delta_{i+1}^N$ and also wind γ_D^i around each branch cut it passes through, see figure 2.2.2. Therefore the monodromy matrix is

$$M = \begin{pmatrix} 1 & Q \\ 0 & 1 \end{pmatrix} \begin{pmatrix} {}^t P^{-1} & 0 \\ 0 & P \end{pmatrix} \quad (2.59)$$

With Q a $N-1 \times N-1$ matrix to be determined. The second matrix implements $\gamma_i \rightarrow \gamma_{i+1}$, the factor of ${}^t P^{-1}$ is present as γ_D^i are only affected by the rotation of the individual pairs not the overall rotation of the whole system. The first matrix

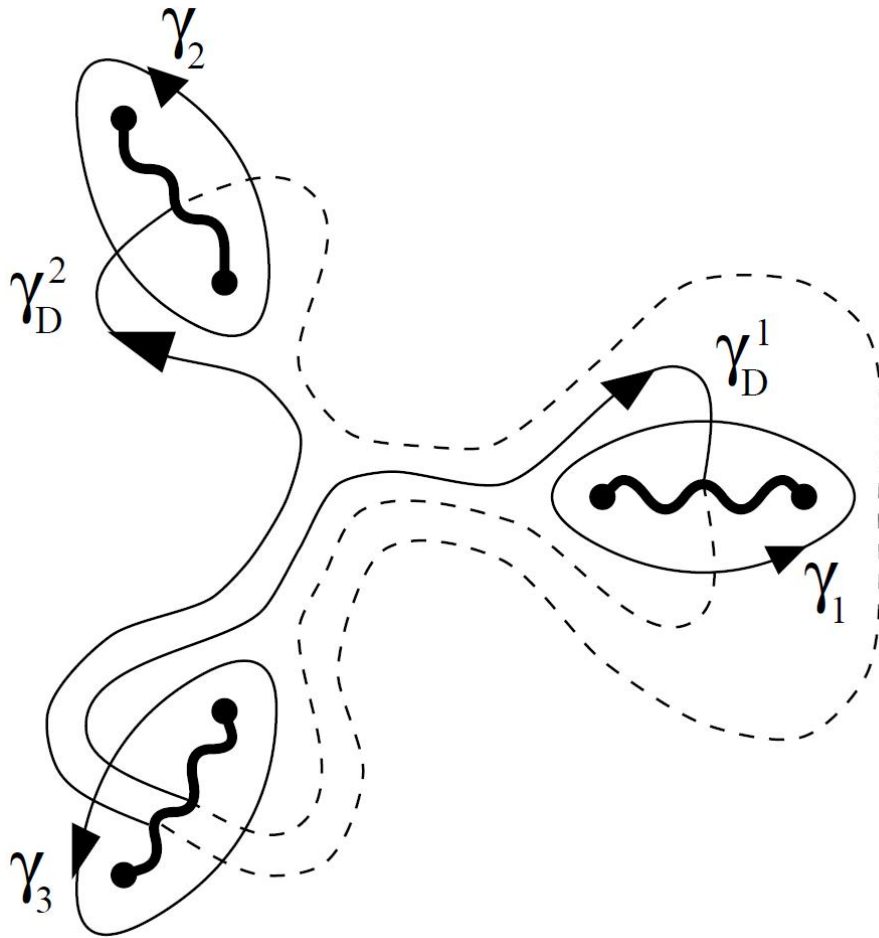

Figure 2-1: Here the arrangement of branch cuts and labelling of the cycles for $SU(3)$ is depicted. (This figure is taken from [3])

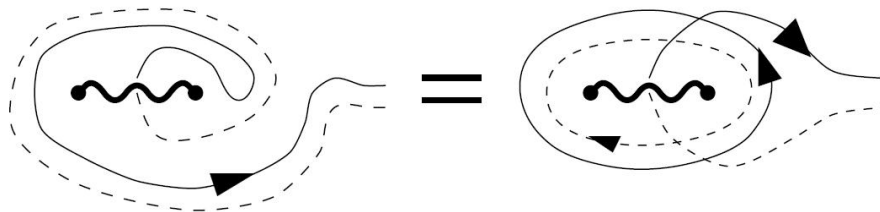

Figure 2-2: On the left a full rotation of the branch cut has resulted in γ_D being wound around it. By deforming the cycles one sees that it is equivalent to the scenario depicted on the right (This figure is taken from [3])

corresponds to the winding of γ_D^i about a branch cut. These two operations commute and combining this with the former operation being order N gives

$$M^N = \begin{pmatrix} 1 & NQ \\ 0 & 1 \end{pmatrix} \quad (2.60)$$

After traversing the path in the s_N plane N times, γ_D^i is wound N times around each cut that it intersects, namely the i^{th} and N^{th} . These can be unwound by the procedure illustrated in figure 2.2.2 giving

$$\gamma_D^i \rightarrow \gamma_D^i - 2N\gamma_i + 2N\gamma_N = \delta_j^i \gamma_D^j + NQ^i j \gamma_j, \quad Q^{ij} = -2(\delta^{ij} + 1) \quad (2.61)$$

The different signs in front of the factors of 2 arise as $\langle \gamma_D^i, \gamma_i \rangle = 1$ but $\langle \gamma_D^i, \gamma_N \rangle = \langle \gamma_D^i, -\sum_j^{N-1} \gamma_j \rangle = -1$. Using 2.61 in 2.59 gives the monodromy matrix M .

This must now be checked against the result on the gauge theory side. At weak coupling $a_D^i = \tau^{ij} a_j$ where

$$\tau^{ij} = \frac{i}{2\pi} \left[\delta^{ij} \sum_k \ln a_{ik} a_{ki} + \delta^{ij} \ln a_{in} a_{ni} - \ln a_{ij} a_{ji} + \sum_k (\delta^{ik} + \delta^{jk} + 1) \ln a_{kn} a_{nk} \right] \quad (2.62)$$

and $a_{ij} = |a_i - a_j|$. Performing $s_N \rightarrow e^{2\pi i} s_N, a_i \rightarrow a_{i+1}$ implies $a_{ij} \rightarrow e^{2\pi i/N} a_{ij}$ and $\ln a_{ij} a_{ji} \rightarrow \ln a_{ij} a_{ji} + 2\pi i (\frac{2}{N})$ and hence $\tau^{ij} \rightarrow \tau^{ij} + Q^{ij}$,

$$a_D^i = \tau^{ij} a_j \rightarrow \tau^{ij} P_j^k a_k + Q^{ij} P_j^k a_k \quad (2.63)$$

This looks different from 2.61 but the low energy couplings are symmetric in each of the $U(1)$ factors $\Rightarrow \tau P = {}^t P^{-1} \tau$, which agrees with the SW curve result. For $SU(2)$ it was seen that M_∞ factorised into two, a classical part P and a quantum one T^{-2} . The same is true here $\begin{pmatrix} 1 & Q \\ 0 & 1 \end{pmatrix}$ being the quantum part that can be attributed to the logarithm in 2.62.

2.2.3 Strong Coupling Monodromies

As was the case for $SU(2)$, strong coupling singularities in the moduli space indicate that dyons or monopoles are becoming massless. The mass of BPS state is given by the central charge 2.20 and in the appropriate local coordinates the singularity is located at $n_m a_D(u) + n_e a(u) = 0$ which is a complex codimension 1 locus. This picture becomes more intricate when higher rank groups are considered. The loci where single dyons become massless are now $N - 2$ complex dimensional submanifolds. These are allowed to intersect and at these intersections multiple dyons will become massless.

If the massless states correspond to cycles that do not intersect then they are called mutually local. At vacua with mutually local massless dyons a duality transformation can be performed. The dual theory is weakly coupled and each of the massless states will be coupled ‘electrically’ to different $U(1)$ factors. If, on the other hand, the cycles intersect the massless states are called mutually non local. There is no duality transformation that can bring this to a theory with only electric degrees of freedom. Such regions with mutually non local massless dyons are known as Argyres-Douglas (AD) loci, in this region the theory has no Lagrangian description. In fact these AD loci provided the first explicit construction of non local theories. Monodromies are encountered when one circles about a singular manifold. The monodromies due to each individual massless state will commute if they are mutually local but wont if they are non local.

To begin, consider the singularity, P , due to a single massless dyon of charge $\underline{n} = (\underline{n}_m, \underline{n}_e)^t$. Near P a duality transformation $\underline{A} \rightarrow U\underline{A}$, can be performed, The theory is a $U(1)$ theory which flows to zero coupling and the charge is $\tilde{\underline{n}} = (0, \tilde{\underline{n}}_e)^t$. In local coordinates, \tilde{a} , the location of P is given by $\tilde{a} = 0$ and

$$\tau^{ij} = \frac{-i}{2\pi} \delta^{ij} (\tilde{n}_e^i)^2 \ln(\tilde{n}_e^i \tilde{a}_i) \quad (2.64)$$

The monodromy about this is then

$$M' = \begin{pmatrix} \text{Id} & (\tilde{n}_e^i)^2 \\ 0 & \text{Id} \end{pmatrix} \quad (2.65)$$

This matrix can then be conjugated by U to give the general strong coupling monodromy matrix

$$M' = \begin{pmatrix} \text{Id} + n_e^i n_m^j & n_e^i n_e^j \\ -n_m^i n_m^j & \text{Id} - n_m^j n_e^i \end{pmatrix} \quad (2.66)$$

To study the monodromies produced by the SW curve, one must first locate the strong coupling singularities and determine their type. This can be done by considering the discriminant of the polynomial on the right hand side of 2.53, $F(x) = (P(x) - \Lambda^N)(P(x) + \Lambda^N) = F_-(x)F_+(x)$,

$$\Delta(F(x)) = \Delta(F_-)\Delta(F_+) \prod_{i < j} (a_i^+ - a_j^-)^2 \quad (2.67)$$

Where a_i^\pm are the roots of F_\pm . Using $F_+ - F_- = 2\Lambda^N$ and $\prod_{i < j} (a_i^+ - a_j^-)^2 = \prod_i (F_+(a_i^-))^2$ one sees

$$\Delta(F) = 2^{2N} \Lambda^{2N^2} \Delta(F_-)\Delta(F_+) \quad (2.68)$$

The vanishing of the discriminant signals a multiple root and so the collision of branch points or in other words singularities of the moduli space. When only one of $\Delta(F_\pm) = 0$ a single dyon becomes massless, when both are zero there are multiple massless dyons. These may be mutually local or non local. They are mutually non local if either of $\frac{\partial F_\pm}{\partial s_k} = 0, \forall k$ at these points also.

To continue further, we specialise to the case of $SU(3)$ and use the SW curve to study the different singularities and check the monodromies are correct. The SW curve is

$$y^2 = (x^3 + s_2x + s_3)^2 - \Lambda^6 = (x^3 - ux - v)^2 - \Lambda^6 \quad (2.69)$$

The discriminants are $\Delta(F_\pm) = 4u^3 - 27(v \pm 2\Lambda^3)^2$. There are thus 6 singular submanifolds where a single dyon becomes massless. In addition there are 5 points of

intersection between these. There are three located at $v = 0, u^3 = (3\Lambda^2)^3$, called \mathbb{Z}_2 vacua. They preserve this subset of the global \mathbb{Z}_6 symmetry and involve two mutually local states becoming massless. They are rotated into each other by $u \rightarrow e^{2\pi i/3}u$. The other two are at $u = 0, v = \pm 2\Lambda^3$ and are called \mathbb{Z}_3 vacua. At the \mathbb{Z}_3 vacua three mutually non local dyons become massless. The \mathbb{Z}_2 points are not lifted when one breaks to $\mathcal{N} = 1$ supersymmetry via the addition of a superpotential and are thus the $\mathcal{N} = 1$ vacua. In general there are $N - 1$ points where the maximum number of mutually local dyons become massless. These are the $N - 1$ different vacua for the $\mathcal{N} = 1$ $SU(N)$ gauge theory.

Computing all strong coupling monodromies can be a lengthy process, especially as their number increases rapidly as the rank goes up. Here we restrict to computing one of the \mathbb{Z}_3 monodromies. Using the local coordinates near the vacuum, $s_2 \rightarrow s_2 - 2^{\frac{2}{3}}3\Lambda^2$ with $|s_k| \ll \Lambda^k$ the curve is

$$y^2 = (x - 1 + \sqrt{s_2 + s_3})(x - 1 - \sqrt{s_2 + s_3})(x + 1 + \sqrt{s_2 + s_3})(x + 1 - \sqrt{s_2 + s_3})(x^2 - 4) \quad (2.70)$$

(Λ has been set as $2^{1/3}$ for convenience). There are two branch cuts located near ± 1 . First look at the branch cut stretching between $1 + \sqrt{s_2 + s_3}$ and $1 - \sqrt{s_2 + s_3}$. Traversing at path in the $s_2 + s_3$ plane $s_2 + s_3 \rightarrow e^{2\pi i}(s_2 + s_3)$ keeping $s_2 - s_3$ fixed, causes the branch cut to perform a 180° rotation about its centre point. This leaves $\gamma^1, \gamma^2, \gamma_D^2, \gamma^3$ unaffected but winds γ_D^1 around the cut. This can be unwound as in figure 2.2.2 to give $\gamma_D^1 + \gamma^1$. Note the factor of two is missing as is the γ_3 , this is because the cut was only rotated half way while the cut encircled by γ_3 was unaffected. If instead one follows the path $s_2 - s_3 \rightarrow e^{2\pi i}(s_2 - s_3)$ with $s_2 + s_3$ fixed, the other branch cut near -1 is rotated with similar effect. The two monodromies are thus

$$M_1 = \begin{pmatrix} 1 & 0 & 1 & 0 \\ 0 & 1 & 0 & 0 \\ 0 & 0 & 1 & 0 \\ 0 & 0 & 0 & 1 \end{pmatrix}, \quad M_2 = \begin{pmatrix} 1 & 0 & 0 & 0 \\ 0 & 1 & 0 & 1 \\ 0 & 0 & 1 & 0 \\ 0 & 0 & 0 & 1 \end{pmatrix} \quad (2.71)$$

Which are the same as those in 2.65. Conjugating these matrices by the duality transformation that took us to the local coordinates will bring them to the form 2.66 which allows one to read off the charges of the massless dyons. Doing this for all the \mathbb{Z}_2 vacua gives the following set of dyon charges.

$$\begin{aligned}
\underline{n}_1 &= (1, 1, -1, 0) & \underline{n}_2 &= (0, 1, -1, 1) \\
\underline{n}_3 &= (1, 0, -1, 1) & \underline{n}_4 &= (0, 1, -1, 1) \\
\underline{n}_5 &= (0, 1, 0, -1) & \underline{n}_6 &= (1, 0, 1, 0)
\end{aligned} \tag{2.72}$$

They are arranged so that the rows are pairs of mutually local dyons that become massless at the \mathbb{Z}_2 vacua. The columns are the three mutually non local dyons that become massless at \mathbb{Z}_3 vacua.

2.2.4 SW Differential

In order to be able to equate the couplings and the period matrix of the Riemann surface the SW differential is required. For higher genus surfaces the period matrix is given by $\tau^{ij} = \sum_l A_l^i (B^{-1})^{lj}$ where

$$A_l^i = \frac{\partial a_D^i}{\partial s_l} = \int_{\gamma_D^i} \lambda_l, \quad B_{jl} = \frac{\partial a_j}{\partial s_l} = \int_{\gamma_j} \lambda_l \tag{2.73}$$

Here $\lambda_l = \frac{x^{N-l} dx}{y}$, $l = 2, \dots, N$ form a basis of holomorphic differentials on the surface.

In order to have

$$a_D^i = \int_{\gamma_D^i} \lambda, \quad a^i = \int_{\gamma^i} \lambda \tag{2.74}$$

the SW differential must satisfy the following condition

$$\frac{\partial \lambda}{\partial s_l} \propto \lambda_l \tag{2.75}$$

up to the addition of an exact form. Which can be done by choosing

$$\lambda = \frac{-1}{2\pi} \frac{\partial P}{\partial x} \frac{x dx}{y} \tag{2.76}$$

by differentiating λ one sees that the condition is indeed satisfied up to the exact form $\frac{1}{2\pi}d\left(\frac{x^{N+1-l}}{y}\right)$ with proportionality constant $\frac{1}{2\pi}$. Other definitions of the differential are possible but 2.76 is the simplest.

2.2.5 SU(2) revisited

The SW curve, 2.53, derived in this section applied to gauge group $SU(2)$ gives

$$y^2 = (x^2 - u)^2 - \Lambda^4, \quad u = -s_2 \quad (2.77)$$

which seems considerably different from 2.32, for one thing the curve above is quintic as opposed to cubic. It has already been discussed, however that polynomials of degree $2N$ and $2N - 1$ can both be used to describe a genus $N - 1$ curve. In fact one can map 2.32 to 2.77 via a fractional linear transformation which takes the branch points of one curve to the other. This brings all the branch points to finite values of x , putting them all on the same level.

2.2.6 Other Classical Groups

Given that the SW curve for any unitary gauge group is simply a classical curve perturbed by a one instanton process it is straightforward to generalise this to other classical groups. As an example consider rank r orthogonal groups. The condition that $\langle\phi\rangle$ is in the Cartan of the gauge group means that

$$\langle\phi\rangle = \text{diag}(A_1, \dots, A_r), \quad A_i = \begin{pmatrix} 0 & a_i \\ -a_i & 0 \end{pmatrix} \quad (2.78)$$

The moduli space is parametrised by the gauge invariant parameter u_{2k} which at weak coupling are

$$u_{2k} = \sum_{i=1}^r a_i^{2k} \quad (2.79)$$

or the elementary symmetric polynomials $s_{2k} = (-1)^k \sum_{i_1 < \dots < i_k} a_{i_1}^2 \dots a_{i_k}^2$ which are related to the u_{2k} s by 2.51 with $s_0 = 1, s_2 = 0$. Thus the SW curves for $SO(N)$ are

$$y^2 = \left(\sum_{k=0}^r s_{2k} x^{2r-k} \right)^2 - \Lambda^{2(N-2)} x^2 \quad N \text{ odd} \quad (2.80)$$

$$y^2 = \left(\sum_{k=0}^r s_{2k} x^{2r-k} \right)^2 - \Lambda^{2(N-2)} x^4 \quad N \text{ even} \quad (2.81)$$

The coefficients of the instanton factors ensure that the curves have the correct transformation properties under the R-symmetries. The SW differential is the same as for the unitary curves.

2.3 Seiberg-Witten Curves with matter

2.3.1 Central Charge and Duality

Before attempting to derive the SW curves, a few facts regarding supersymmetric gauge theories with matter must be stated. First, coupling hypers to the gauge theory requires adding a hypermultiplet kinetic term to the Lagrangian as well as the superpotential

$$\mathcal{W} = \sqrt{2} \tilde{Q}_a^i \Phi_j^j Q_j^a + \sum_a m_a \tilde{Q}_a^i Q_i^a \quad (2.82)$$

$a = 1, \dots, N_f$. The global symmetry now contains an extra group factor called the flavor symmetry. Classically this is $U(N_f)$ but can enjoy some enhancement depending on the representation of the hypers. If they transform in a real rep of the gauge group the flavor symmetry is $Sp(2N_f)$ while if the rep is pseudo real it is $SO(2N_f)$. Generically non zero masses will break the flavor symmetry to $U(1)^{N_f}$.

The central charge was earlier identified with the mass of a BPS state, $M = \sqrt{2}|Z|$, and as such should be modified by the inclusion of bare masses to

$$Z = n_m^i a_D^i + n_e^i a^i + S_a m_a \quad (2.83)$$

where S_a is the $U(1)$ charge of the a^{th} massive hyper. Fundamental quarks have $S_a = \pm 1$. In the previous chapter all fields transformed in the adjoint of the gauge group and a choice was made so that they had integral charges. Under this, fundamental hypers had half integral charge. One can ensure all particles have integral charge by multiplying n_e^i by 2 and dividing a by 2 which keeps 2.83 invariant. These are also accompanied by a rescaling of the coupling to $\tau(a) = \frac{\theta}{\pi} + \frac{8\pi i}{g(a)^2}$.

The extra bare mass terms in the central charge facilitate an enlargement of the duality group from $Sp(2r, \mathbb{Z})$ for a pure theory to $Sp(2r, \mathbb{Z}) \times (\mathbb{Z})^{N_f}$ when matter is included. When duality was encountered previously it was noted that the group could actually have the action $\underline{a} \rightarrow M\underline{a} + c$ but the shift was precluded as it could not be compensated for. The new terms provide a way to compensate for such a shift and the group is enlarged accordingly. The action is now

$$\underline{a} \rightarrow M\underline{a} + C\underline{m}, \quad \underline{n} \rightarrow {}^t M^{-1}\underline{n} \quad (2.84)$$

$$\text{and } \underline{S} \rightarrow \underline{S} - C\underline{n} \quad (2.85)$$

where $C = \begin{pmatrix} S_a n_e^i \\ -S_a n_j^m \end{pmatrix}$ is a $2N - 2 \times N_f$ integer matrix and M given by 2.66.

2.3.2 Singularities

The introduction of matter causes further singularities in the moduli space which are due to massless quarks rather than massless dyons. To study these singularities we consider $G = SU(2)$, $N_f = 3$ with degenerate masses $m_a = m \gg \Lambda, \forall a$. The flavor symmetry $Spin(6) = SU(4)^1$ is broken to $SU(3) \times U(1)$ by the non zero bare masses. There are singularities when $|a + S_a m_a| = 0$, setting $S_a = 1$ means that there is a single singularity at weak coupling $a + m = 0$. At this point three quarks become massless. These three quarks transform in the $\underline{3}$ of the flavor symmetry. At a point

¹The fundamental of $SU(2)$ is pseudo real so there is an enhancement of the flavor symmetry to $SO(2N_f)$. The hypers transform as $2N_f$ half hypers in the fundamental of $SO(2N_f)$. Like instantons the monopoles of the theory also have zero modes, one per left handed fermion in the fundamental of the gauge group. There are thus $2N_f$ fermion zero modes for the monopole. These form a $2N_f$ dimensional Dirac algebra, therefore the monopole transforms as a spinor of $SO(2N_f)$ this suggests that the quantum flavor symmetry is $Spin(2N_f)$.

in \mathcal{M} with $u \ll m^2$ the quarks have no effect and the theory has $N_f = 0$. By the renormalisation group matching $\Lambda^4 = m^3 \Lambda'$ where Λ is the dynamically generated scale of the $N_f = 0$ theory and Λ' is that of the $N_f = 3$ theory.

By decreasing the bare mass the quark singularity will move away from the weak coupling region. If the bare mass vanishes then the full $SU(4)$ flavor symmetry is restored. The massless fields at the singularities must now form representations of $SU(4)$. There are five massless fields shared over the singularities. To be consistent with the flavor symmetry there must be only two singularities, one with fields in the $\underline{4}$ of $SU(4)$ and the other with a flavor singlet field, both of which are at strong coupling. Naively one might think that the quark singularity has combined with one of the other singularities and the four massless fields are simply three quarks and one dyon (or monopole) this is not the case however. The four fields all have charge $(1, 0)$ while at the other singularity the singlet field has charge $(2, 1)$.

The cases of $N_f = 1, 2$ can similarly be analysed although in these cases the R-symmetry further constrains the singularities. When m is large the quark singularity is at weak coupling and the massless fields transform in reps of the broken flavor symmetry. At $u \ll m^2$ the theory appears to be $N_f = 0$ and there are the usual two strong coupling monodromies with massless flavor singlet fields. For $N_f = 2$ there is a \mathbb{Z}_2 symmetry and when $m = 0$ the full flavor symmetry $Spin(4) = SU(2) \times SU(2)$ is restored. This suggests that there are only two singularities with two massless fields at each. They transform in the spinors of $Spin(4)$. If $N_f = 1$ then there is a \mathbb{Z}_3 symmetry implying that there are always three singularities each with one massless field in a singlet of $SO(2)$.

2.3.3 SW Curves

Having studied the SW curves without matter and the new effects and features encountered when it is introduced we can now state some rules for the construction of the curves with $N_f < 2N_c$.

Classical Curve: The curve should take the form of some classical curve perturbed by instanton corrections. When $\Lambda \rightarrow 0$ this classical curve should emerge. In addition the discriminant of the full curve should have zeros at the singularities. Therefore as $\Lambda \rightarrow 0$ it should be of the form

$$\Delta \propto \Delta_{N_c}^2 \Delta_{N_f N_c} \quad (2.86)$$

where $\Delta_{N_c}^2 = \prod (a_i - a_j)^2$ is the factor due to the symmetry breaking of the gauge theory and $\Delta_{N_f, N_c} = \prod_{a=1}^{N_f} \sum_{k=0}^{N_c} (s_k (-m_a)^{N_c - k})$ has zeros at the quark singularities $a_i + m_a = 0$. The order of vanishing of the discriminant indicates the number of fields becoming massless at that point as it is the number of codimension 1 varieties that intersect there. This is also the dimension of the representation of flavor symmetry that the fields transform in.

Instantons: The instanton corrections should be proportional to the one instanton amplitude. They take the form

$$\Lambda^{2N_c - N_f} \quad (2.87)$$

R Symmetry: The curve should exhibit symmetry under $\mathbb{Z}_{2N_c - N_f}$. This is achieved by the following assignment of charges

y	x	m_a	Λ	u_k	s_k
N_c	1	1	1	k	k

The assignment of charge 1 to Λ will restore the full $U(1)_{\mathcal{R}}$ symmetry of the curve.

Integrating out a flavor: A flavor can be integrated out by sending a bare mass to infinity $m \rightarrow \infty$ such that

$$\Lambda_{N_f - 1}^{2N_c - N_f + 1} = m \Lambda_{N_f}^{2N_c - N_f} \quad (2.88)$$

is held fixed. Upon doing this the resulting curve should be of the form of a $N_f - 1$ theory.

SW Differential: The SW differential was constrained to be holomorphic when there was no matter present. The new form of the duality transformation now allows for poles provided that the residues are linear combinations of the bare masses

$$2\pi i \text{Res}(\lambda) = \sum_a n_a m_a, \quad n_a \in \mathbb{Z} \quad (2.89)$$

2.3.4 Examples of Curves

The most general form of the curve when $N_f < N_c$ is

$$y^2 = P(x)^2 - \Lambda^{2N_c - N_f} G(x, m_a) \quad (2.90)$$

The first factor is required so that the classical symmetry breaking of the gauge group is reproduced. Only one instanton processes can be used due to the R-symmetry charge which also implies that $G(x, m_a)$ is a degree N_f polynomial in x, m_a . $G(x, m_a)$ must also be symmetric in m_a which suggests the curve for $SU(N_c), N_f < N_c$ is

$$y^2 = P(x)^2 - \Lambda^{2N_c - N_f} \prod_{a=1}^{N_f} (x + m_a) \quad (2.91)$$

This can be confirmed by using the residue properties of the SW differential

$$\lambda = \frac{x dx}{2\pi i y} \left[\frac{P G'}{G} - P' \right] \quad (2.92)$$

Which has poles at ϵ_a , the zeros of G . At these points $y = \pm P(\epsilon_a)$ which combined with $\text{Res}(\frac{G'}{G})|_{x=\epsilon_a} = n_a$ n_a being the order of the pole implies $2\pi i \text{Res}(\lambda)|_{x=\epsilon_a} = \pm n_a \epsilon_a$. Which confirms $G(x, m_a) = \prod_{a=1}^{N_f} (x + m_a)$. The sign in front on the instanton factor is chosen so as to reduce to 2.53 upon integration of a quark. As an example consider $N_c = 3, N_f = 1$,

$$y^2 = (x^3 - ux - v)^2 - \Lambda_1^5 (x + m) \quad (2.93)$$

If one sends $m \rightarrow \infty$ and $\Lambda_1 \rightarrow 0$ such that $\Lambda_1^5 m = \Lambda_0^6$ 2.93 reduces to the $N_f = 0$ curve 2.69. The discriminant of this polynomial can be calculated and to lowest order in Λ_1 is

$$64\Lambda_1^{15}(4u^3 - 27v^3)(m^3 - mu - v) + \mathcal{O}(\Lambda_1^{16}) \quad (2.94)$$

which exhibits the correct singularity structure.

When $2N_c > N_f \geq N_c$ two instanton processes are allowed by R-symmetries. Using the same methods as above the SW curves can be calculated. To save on space the result will just be presented ([11])

$$y^2 = (P(x) + \Lambda^{2N_c - N_f} H(x, m_a))^2 - \Lambda^{2N_c - N_f} \prod_{a=1}^{N_f} (x + m_a) \quad (2.95)$$

$H(x, m_a)$ is a degree $N_f - N_c$ polynomial in x and m_a . The requirement that H be symmetric in m_a fixes it to be

$$H(x, m_a) = \frac{1}{4} \sum_{k=0}^{N_f - N_c} x^{N_f - N_c - k} t_k(m), \quad t_k(m) = \sum_{a_1 < \dots < a_k} m_{i_1} \dots m_{i_k} \quad (2.96)$$

The factor of $1/4$ comes from matching to the curves which are derived from first principles for $SU(2)$ in [2]. 2.95 can be used as the curve for all $N_f < 2N_c$ theories by choosing $H = 0$ when it has negative degree. By letting $Q = P(x) + \Lambda^{2N_c - N_f} H(x, m_a)$ the SW differential is given by

$$\lambda = \frac{x dx}{2\pi i y} \left[\frac{Q G'}{G} - Q' \right] \quad (2.97)$$

2.3.5 Theories with $N_f = 2N_c$

The case of $N_f = 2N_c$ needs to be considered separately as the theory has vanishing β function. The main implication for the SW curves is that there can now be explicit dependence on the UV gauge coupling τ . The method of derivation presented here is from [10] and uses the same principles as the previous cases. The procedure will take a top down approach instead, the most general curve is proposed for $SU(2N_c)$, $N_f =$

$2N_c$ and reduced to the desired curve by integrating out colors. The curve is further constrained by matching to solutions derived from first principles in [2].

The most general curve for $SU(2N_c)$, $N_f = 2N_c$ is that of the classical curve $\tilde{P}(x)^2$ perturbed by instanton effects (The variables of the larger asymptotically free theory are denoted by tildes). Both one and two instanton processes can be included as the amplitude is proportional to Λ^{2N_c} thus giving

$$y^2 = \tilde{P}^2 - \Lambda^{2N_c} \tilde{Q} + \Lambda^{4N_c} \tilde{R} \quad (2.98)$$

Here $\tilde{P}, \tilde{Q}, \tilde{R}$ are degree $4N_c, 2N_c, 0$ polynomials. The gauge group can be broken $SU(2N_c) \rightarrow SU(N_c) \times SU(N_c)' \times U(1)$ by letting $\tilde{a}_i = M + a_i, i = 1, \dots, N_c$ and $\tilde{a}_j = -M + a_j, j = N_c + 1, \dots, 2N_c$. Only quarks coupled to the first $SU(N_c)$ should be left after the decoupling limit is taken. This is achieved by choosing $\tilde{m}_a = -M + m_a$, $M \gg a_i, a_j, m_a$.

To decouple the $SU(N_c)'$ gauge group one takes the limit $M \rightarrow \infty$ while holding $(\frac{\Lambda}{M})^{2N} \propto q \equiv e^{i\pi\tau}$. The right hand side of this expression comes from the renormalisation group matching but is only perturbatively correct. To take into account possible instanton corrections let $(\frac{\Lambda}{M})^{2N} = f(q)$ with $f(q) \propto q + \mathcal{O}(q^2)$ at weak coupling.

The bare masses may also be renormalised in this limit. There are two possible renormalisations, one for the trace of the mass matrix which is a flavor singlet and the other for the traceless part, which transforms in the adjoint of $SU(N_f)$. Denoting the singlet by $\mu = 1/N_f \sum m_a$ and the adjoint masses $\mu_a = m_a - \mu$ one has $\tilde{m}_a = -M + \mu + \mu_a$ at weak coupling but the correct matching condition is

$$\tilde{m}_a = \tilde{\mu} + \tilde{\mu}_a = (-M + g(q)\mu) + h(q)\mu_a \quad (2.99)$$

Where $g(q), h(q) \sim 1 + \mathcal{O}(q)$.

Taking this limit in the SW curve should correspond to the degeneration of the Riemann surface into two parts each with genus $g = N_c - 1$. Making these substitu-

tions in 2.98 gives

$$y^2 = \prod_{i=1}^{N_c} (x - M - a_i)^2 \prod_{j=N_c+1}^{2N_c} (x - M - a_j)^2 - \Lambda^{2N_c} \tilde{Q} + \Lambda^{4N_c} \tilde{R} \quad (2.100)$$

A shift of $x \rightarrow x + M$ will take $\tilde{P}^2 = \prod_{i=1}^{N_c} (x - M - a_i)^2 \prod_{i=j}^{N_c} (x - M - a_j)^2$ to $\sim x^{2N_c} (x + 2M)^{2N_c}$. This has $2N_c$ branch points near $x = 0$ and $2N_c$ near $x = -2M$ and so describes the degeneration sought. The rest of the curve must also factorise in such a fashion. After a rescaling $y \rightarrow (2M)^{N_c} y$ and for $x \ll M$ the curve becomes

$$y^2 = P(x)^2 - f(q) \tilde{Q}(x + M, \tilde{m}_a, \tilde{a}_i) + f(q)^2 M^{2N_c} \tilde{R} \quad (2.101)$$

This should be the curve for $SU(N_c)$, $N_f = 2N_c$. It can only depend on the $SU(N_c)$ parameters and not the $SU(N_c)'$ ones and must be independent of M . Therefore $\tilde{R} = 0$ and $\tilde{Q}(x + M, \tilde{m}_a, \tilde{a}_i) = \tilde{Q}(x + g(q)\mu, h(q)\mu_a)$. To determine the form of \tilde{Q} the SW differential is used in the same way as the previous section with a slight modification.

In the present context it is convenient to use a different form of the SW differential

$$\lambda = a \ln \left(\frac{P - y}{P + y} \right) dx \quad (2.102)$$

This satisfies the conditions 2.75 and so is a valid differential. It does however have logarithmic singularities at $\tilde{Q}(\epsilon_a) = 0$, these can be turned into poles however by adding the exact form

$$d \left[a(x + b) \ln \left(\frac{P + y}{P - y} \right) \right] \quad (2.103)$$

which does not affect the conditions 2.75. The resulting differential is

$$\lambda = a(x + b) d \left[\ln \left(\frac{P - y}{P + y} \right) \right] \quad (2.104)$$

There are now poles at $x = \epsilon_a$ the residues of which are $\pm a(\epsilon_a + b)$. The zeros of \tilde{Q} are thus linear combinations of the masses which can only appear in the curve

in flavor symmetric combinations. This implies $\tilde{Q} = \prod(x + g(q)\mu + h(q)\mu_a)$. One renormalisation can be set to 1 by a redefinition of the coupling, $h = 1$. The condition on the poles of λ is that the residues are linear in the bare masses. Using this the constants a, b are found

$$\pm 2\pi i a(\epsilon_a + b) = \mp m_a = \mp(\mu + \mu_a) \Rightarrow a = \frac{1}{2\pi i}, b = (g - 1)\mu \quad (2.105)$$

With these values the SW differential has a pole at ∞ with residue $\pm 2N_c \mu g(1 - f)^{-1/2}$. This can be made to satisfy the residue condition by setting $f = (1 - g^2)^{1/2}$. The final form of the curve is

$$y^2 = P(x)^2 - (1 - g(q)^2) \prod_{a=1}^{2N_c} (x + g(q)\mu + \mu_a) \quad (2.106)$$

The function $g(q)$ is as yet undetermined. To do this requires matching to the curve for $SU(2), N_f = 4$ which is derived from first principles in [2]. The result is given in terms of the Jacobi theta functions

$$g(q) = \frac{\theta_2^4 + \theta_1^4}{\theta_2^4 - \theta_1^4} \text{ or } g(q) = \frac{\theta_3^4 - \theta_1^4}{\theta_3^4 + \theta_1^4} \quad (2.107)$$

Where $\theta_1^4 = 16q + \mathcal{O}(q^3)$, $\theta_2^4 = 1 = 8q + \mathcal{O}(q^2)$, $\theta_3^4 = 1 + 8q + \mathcal{O}(q^2)$. They have the properties $\theta_1^4(\tau + 1) = -\theta_1^4(\tau)$, $\theta_2^4(\tau + 1) = \theta_3^4(\tau)$, $\theta_3^4(\tau + 1) = \theta_2^4(\tau)$ and $\theta_1^4(\frac{-1}{\tau}) = -\tau^2 \theta_2^4$, $\theta_2^4(\frac{-1}{\tau}) = -\tau^2 \theta_1^4$, $\theta_3^4(\frac{-1}{\tau}) = -\tau^2 \theta_3^4$. Therefore the two possibilities are related by $\tau \rightarrow \tau + 1$ and invariant under $\tau \rightarrow \tau + 2$. The curve is also invariant under $\tau \rightarrow -1/\tau$ if $\mu \rightarrow -\mu$ which suggests that the S-duality group of $SU(N_c), N_f = 2N_c$ is $\tilde{\Gamma}_0(2)$.

The SW curve governs the low energy behaviour of the gauge theory, meaning that $\tilde{\Gamma}_0(2)$ may only appear to be the S-duality group at low energies. In [14], however, it was shown to be exact. This was done by embedding the scale invariant theory in a larger asymptotically free theory. By scaling appropriately it was found that the coupling space of the smaller theory is a submanifold of the Coulomb branch of the larger theory. The exact global symmetries of Coulomb branch are inherited by the

coupling space and become the S-duality group.

Curves for other classical gauge groups with matter can be constructed using the methods presented in this section [12], [13]. The next chapter however, will see the introduction of a more intuitive method for constructing all SW curves and will be left till then.

3. A String Theory Perspective

In this section Type IIA string theory and its S-dual theory M theory are used to further understand the association between the Coulomb branch of a gauge theory and the moduli space of certain Riemann surfaces. Brane configurations in type IIA which have $\mathcal{N} = 2$, 4d worldvolume (w.v.) theories will be considered. Taking the strong coupling limit of these theories results (via Type IIA S-Duality) in an uplift of the configuration to M theory. It turns out that this is a single M5 brane wrapping a Riemann surface described by the SW curve, Σ_{SW} , of the 4d theory [19].

Thus Σ_{SW} , which was a purely auxiliary object in the field theory, is given a physical interpretation by considering by a string theory embedding. Using this type IIA\M theory picture one can quickly find curves for theories with product gauge groups. These cannot be found via the methods previously espoused as they are not hyperelliptic. This method can also provide a first principles derivation of previously encountered curves, one which does not rely on a hyperelliptic ansatz. The inclusion of symplectic and orthogonal group factors is facilitated by orientifold planes [24] [25] [26].

That an insight such as this is gained via a string theory perspective is not surprising. Previous to [19] field theory phenomena such as Montonen-Olive duality [17] and mirror symmetry in 3 dimensions [18] were given explanations through type IIB string theory. In [18] configurations of D3 branes suspended between NS5 branes and D5 branes are studied. The Coulomb branch of the D3 worldvolume theory is associated to D3s suspended between two NS5s while the Higgs branch to D3s between two D5s. S-duality of type IIB swaps D5s with NS5s and vice versa while keeping D3s invariant. Thus the Higgs and Coulomb branches are exchanged and mirror symmetry

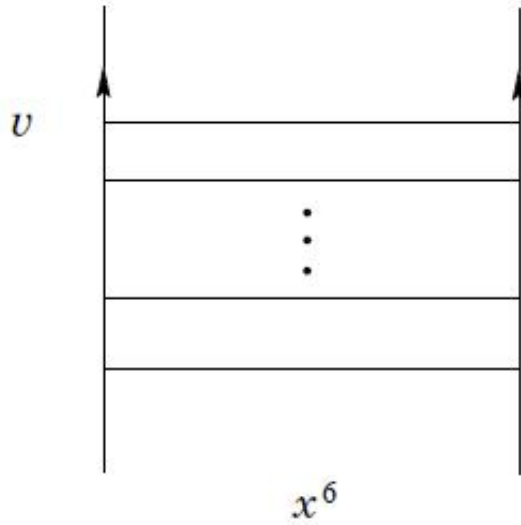

Figure 3-1: A configuration of two NS5s with a number of D4s suspended between them. The vertical axis is the v direction and the horizontal the x^6 direction (this figure is taken from [19]).

is realised as type IIB S-duality. ¹

3.1 Type IIA Brane Configurations, M Theory and Unitary Groups

To obtain a 4d $\mathcal{N} = 2$, theory configurations of D4s suspended between NS5s are considered. All branes span x^μ , $\mu = 0, 1, 2, 3$, which will be the spacetime of the 4d theory and lie at the origin of x^μ , $\mu = 7, 8, 9$. NS5s will also span x^4, x^5 , combined into one complex variable $v = x^4 + ix^5$, while being pointlike in x^6 . The D4s are point like in v and of finite extent in x^6 , being suspended between pairs of NS5s, see figure 3.1. This configuration preserves $\mathcal{N} = 2$ supersymmetry on the worldvolume of the D4s. As they are finite in x^6 the D4 w.v. theory is effectively a 4d $\mathcal{N} = 2$ theory. D6s and orientifolds will later be added without breaking supersymmetry any further. The D6s will span x^μ , $\mu = 0, 1, 2, 3, 7, 8, 9$ and be pointlike in v and x^6 .

¹Mirror symmetry as discussed above is different from the perhaps better known mirror symmetry of Calabi-Yau manifolds although in a string theory setting they are related. In both cases objects which receive no quantum corrections, Higgs branch, are mapped to ones that do, Coulomb branch.

The ends of the D4s are real codimension 2 vortices in the NS5 w.v. As such they introduce a logarithmic branch cut on the NS5. The x^6 position of the NS5 far from NS5-D4 juncture is

$$x^6 = k \ln |v| + \text{constant} \quad (3.1)$$

with k a constant depending on the brane tensions. For multiple D4s with v positions a_i

$$x^6 = k \sum_{i=1} q_i \ln |v - a_i| + \text{constant} \quad (3.2)$$

where $q_i = +1$ if the D4 ends on the right of the NS5 and $q_i = -1$ if it ends on the left. From this one sees that a D4 on the right bends the NS5 such that $x^6 \rightarrow \infty$ as $v \rightarrow \infty$ and a D4 on the left the other way. The $v \rightarrow \infty$ value of x^6 will only be defined if $\sum_i q_i = 0$. The extra dimension of M theory can be incorporated in 3.2 by

$$x^6 + ix^{10} = R \sum_{i=1} q_i \ln(v - a_i) + \text{constant} \quad (3.3)$$

If one encircles a_i by $v \rightarrow e^{2\pi i}v$ then $x^6 + ix^{10} \rightarrow x^6 + i(x^{10} \pm 2\pi)$. The extra coordinate, x^{10} , is periodic in 2π and thus the singularity at the NS5-D4 juncture is cured by uplifting to M theory. Denote $\frac{x^6 + ix^{10}}{R} = s$.

A configuration of $n + 1$ NS5s with k_α D4s suspended between the α^{th} and $\alpha - 1^{th}$ NS5s gives, upon taking a certain limit whereby the NS5 dynamics decouple, a quiver gauge theory with $G = \prod_{\alpha=1}^n SU(k_\alpha)$ see figure 3.1. The gauge group factors being $SU(k_\alpha)$ rather than $U(k_\alpha)$ is set by the following condition.

The α^{th} NS5 kinetic energy due to the adjoining D4s is

$$\int d^4x d^2v (\partial_\mu x^6 \partial^\mu x^6) = k^2 \int d^4x d^2v \left| \partial_\mu \sum_i q_i \text{Re}(\ln(v - a_i)) \right|^2 \quad (3.4)$$

$$= k^2 \int d^4x d^2v \left| \text{Re} \left(\sum_i q_i \partial_\mu a_i \left(\frac{1}{(v - a_i)} \right) \right) \right|^2 \quad (3.5)$$

which converges if $\sum_i q_i \partial_\mu a_i = 0$ or $\sum_i q_i a_i = l_\alpha$, l_α constant. The positions of the D4s, given by the the vevs of the associated V-plets, parameterise the Coulomb

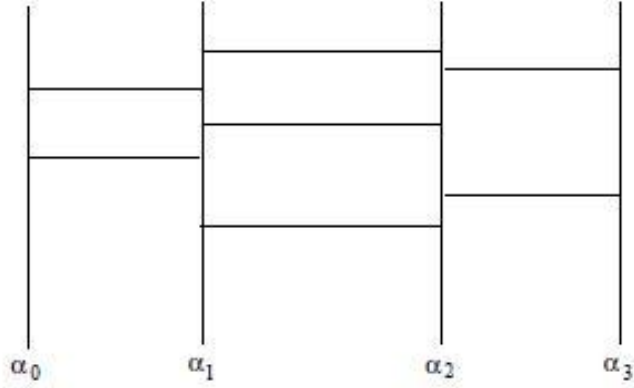

Figure 3-2: A configuration of four NS5s with $k_1 = 2, k_2 = 3, k_3 = 2$ D4s. The gauge group of the 4d w.v. theory is $SU(2)_1 \times SU(3)_2 \times SU(2)_3$ with bifundamental matter in reps $(2_1, \bar{3}_2), (3_2, \bar{2}_3)$ (this figure is taken from [19]).

branch. Thus for the k_α D4s, and so the k_α V-plets, of the α^{th} group factor only $k_\alpha - 1$ are free the other being ‘frozen’ out. The remnant after ‘freezing’ is $SU(k_\alpha)$

3.1.1 Matter Content

The gauge theory is coupled to n hypermultiplets in the bifundamental of adjacent gauge groups i.e in the $(k_1, \bar{k}_2) \oplus (k_2, \bar{k}_3) \oplus \dots \oplus (k_{n-1}, \bar{k}_n)$. One can add fundamentals coupled to $SU(k_1)$ and $SU(k_n)$ by allowing semi-infinite D4s to end on the left of the first and on the right of the last NS5, see figure 3.1.1. As they extend to $\pm\infty$ in x^6 direction they are much heavier than the other D4s and so their dynamics are not seen in the decoupling limit. They only serve to add fundamental flavor and not extra gauge group factors.

the masses of the bifundamentals are

$$m_\alpha = \frac{1}{k_\alpha} \sum_{i=1}^{k_\alpha} a_i - \frac{1}{k_{\alpha+1}} \sum_{j=k_\alpha+1}^{k_\alpha+k_{\alpha+1}} a_j \quad (3.6)$$

i.e the differences of the average positions of D4s on the left and right. The mass of

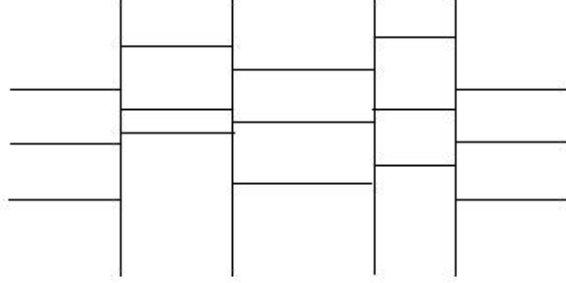

Figure 3-3: A configuration involving semi infinite D4s. Here the quiver theory will have gauge group $SU(3)_1 \times SU(3)_2 \times SU(3)_3$ with two bifundamentals in reps $(3_1, \bar{3}_2)$ and $(3_2, \bar{3}_3)$. The semi infinite D4s couple three hypers each to the the first and last gauge groups. Every group factor is coupled to six hypers, so all β functions vanish (this figure is taken from [19]).

the fundamentals is given by v position of the related D4s.

3.1.2 Coupling Constants

The n coupling constants are encoded in the x^6 separations of neighbouring NS5s

$$\frac{1}{g_\alpha^2(v)} = \frac{x_\alpha^6(v) - x_{\alpha-1}^6(v)}{g_s} \quad (3.7)$$

g_s being the string coupling. The θ parameters are similarly encoded in the x^{10} separations and are combined to give (in appropriate units)

$$-i\tau_\alpha(v) = s_\alpha(v) - s_{\alpha-1}(v) \quad (3.8)$$

for large v (ignoring the D4 positions)

$$-i\tau_\alpha \cong (k_\alpha - k_{\alpha+1} - (k_{\alpha-1} - k_\alpha)) \ln v \quad (3.9)$$

$$= (2k_\alpha - k_{\alpha-1} - k_{\alpha+1}) \ln v \quad (3.10)$$

This is the standard gauge coupling formula for an asymptotically free theory. The scale is set by v and $N_c = k_\alpha$, $N_f = k_{\alpha+1} + k_{\alpha-1}$. Group factors with vanishing

β functions will be later associated to pairs of NS5s that are parallel at ∞

3.1.3 M Theory

The above description of a $\prod_{\alpha=1}^n SU(k_\alpha)$ gauge theory in terms of Type IIA branes is a semi classical one. To explore its full quantum exact properties one must go to strong coupling which coincides with the strong string coupling limit. Strongly coupled Type IIA is S-dual to M theory on S^1 . The NS5s are mapped to M5s and D4s to M5s wrapped on S^1 . All branes span the $\mathbb{R}^{1,3}$ labelled by $x^\mu, \mu = 0, 1, 2, 3$ and are at the origin of $x^\mu, \mu = 7, 8, 9$ so we concentrate on $Q = \mathbb{R}^3 \times S^1$ with coordinates (v, s) . The NS5s span v so are topologically punctured spheres in Q . The D4s are topologically cylinders connecting the NS5 spheres. Thus we see that the whole configuration is in fact a single M5 wrapping a noncompact 2d surface, Σ , embedded in Q . The genus of Σ is $g = \sum_\alpha k_\alpha - 1$. In chapter 5 we will see a different M theory description in which multiple M5s wrap a 2d surface. This description is appropriate when the quiver gauge theory is superconformal.

Working with $t = e^{-s}$ a curve Σ holomorphically embedded in Q can be described as the zero locus of a polynomial in t and v , $F(t, v) = 0$. At fixed v the roots of $F(t, v)$ are the positions of the NS5s. The degree of F in t is $n + 1$, the number of NS5s. To see the form of the polynomial consider the case of $n = 1$, two NS5s with k D4s between them (figure 3.1).

$$A(v)t^2 + B(v)t + C(v) = 0 \tag{3.11}$$

the roots $t_\pm(v)$ give the NS5 positions while for $t_- \leq t \leq t_+$ fixed the solutions $v_i(t)$ give the positions of the D4s, so F is degree k in v . If v is chosen to be a zero of $C(v)$ then $t_- = 0$ and $x^6 = \infty$ for the right hand NS5. This is the same asymptotic bending behaviour seen when a semi infinite D4 joins to the right of the second NS5. Zeros of $C(v)$ are thus interpreted as the positions of such D4s. Likewise a D4 to the first of the left hand NS5 will send $t_+ \rightarrow \infty$ giving $A(v^2)t^2 = 0$. Zeros of $A(v)$ are the positions of semi infinite D4s joining from the left. To get a pure $SU(k)$ theory

set $A = 1$ and $C = \Lambda^{2k}$

$$t^2 + B(v)t + \Lambda^{2k} = 0 \quad (3.12)$$

Shifting $t \rightarrow t + \frac{B}{2}$ to get rid of the linear term

$$t^2 = \frac{B(v)^2}{4} - \Lambda^{2k} = 0 \quad (3.13)$$

Which is the SW curve for a pure $SU(k)$ theory with $B(v) = v^k - \sum_{i=2}^k u_i v^{k-i}$. Thus the SW curve is realised physically through M theory as the 2d surface on which an M5 is wrapped. From now on throughout this chapter the Λ scale will be set to 1 for convenience.

3.1.4 BPS spectrum

The relationship between the BPS spectrum and vanishing cycles of the SW curve can also be explained using M theory. As there are only two dynamical objects in M theory it is perhaps obvious to consider M2 branes as the BPS states of the gauge theory [21],[22],[23]. For an M2 to be the BPS states we want them to be it must couple to the M5 w.v. theory and also appear as a particle in the 4d spacetime. Thus the M2 w.v. must be $\mathbb{R}' \times D$ where $\mathbb{R}' \subset \mathbb{R}^{1,3}$ is the worldline of the BPS particle and $D \subset Q$ such that $\partial D = C$, C a cycle of Σ . In order for such an M2 to be BPS it must be of minimal area. This condition is satisfied if C is a non trivial cycle of Σ and if the M2's contribution to the central charge of the 11d supersymmetry algebra is

$$Z \sim \int_D ds \wedge dv = \int_C \lambda \quad (3.14)$$

Where $\lambda = v \frac{dt}{t}$ is the SW differential for these M theory models. The spectrum of M2 w.v. topologies is interpreted as the spectrum of BPS particles of the gauge theory. If $C = n_m \gamma_D + n_e \gamma$, where γ_D, γ are the cycles as defined in chapter 2, then the resulting BPS particle has charge (n_m, n_e) . The full BPS spectrum of gauge theory can be realised in this manner. For instance in a higher rank gauge theory, the W_{\pm} bosons of the theory are electrically charged under two $U(1)$ s of the low energy theory.

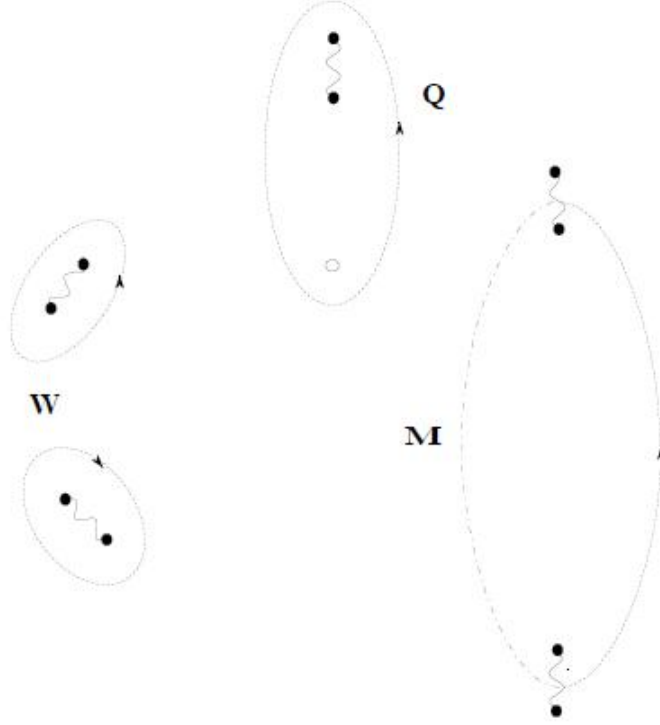

Figure 3-4: The cycles associated with quarks, Q , gauge bosons, W , and monopoles, M . From these one sees that V -plets are interpreted as $M2$ s with the topology of a cylinder while hypers are $M2$ s with the topology of a disc. (this figure is taken from [23]).

The corresponding cycle is $\gamma_i + \gamma_j$. Therefore a W_{\pm} is realised in M theory as an $M2$ with the topology of a cylinder, likewise monopoles and quarks are $M2$ s with the topology of a disc. Generally a V -plet is associated to a cylinder and a hyper to a disc.

The deformation of the $M2$ w.v. can give an insight into the decay of BPS states. A disc can deform to two discs that intersect at a point. Their non zero intersection means that the corresponding cycles intersect. Thus a hyper can decay into two mutually non local hypers, the decay spectrum is the list of pairs of mutually non local particles whose charges add up to the parent's and symplectic product is one. Similarly a cylinder can deform to two discs intersecting at two points, a V -plet can decay into two mutually non local hypers with appropriate conditions on their charges.

3.1.5 Coupling Space

Even though there may be no semi infinite D4s present, the solutions for $t \rightarrow 0, \infty$ still represent the asymptotic bending of the NS5s. The large $|v|$ positions of the first and second NS5s are given by $t \rightarrow \infty, t \simeq cv^k$ and $t \rightarrow 0, t \simeq c'v^{-k}$ respectively. The constants c, c' encode the UV gauge coupling of the theory. This is different from the $k - 1$ IR couplings which come from the period matrix of the SW curve. The IR couplings are dependent on the Coulomb branch parameters $u^{(i)}_\alpha$ while the UV couplings do not. To see this behaviour more clearly, add $2k$ semi infinite D4s to the right of the configuration. The β function vanishes as $N_f = 2N_c$ and the curve, is

$$t^2 = \frac{B(v)^2}{4} - f \prod_{j=1}^{2k} (v - m_j) \quad (3.15)$$

The constant f , present here cannot be omitted even if $\Lambda = 1$, it is actually a function of the gauge coupling not of some scale (c.f ??). For large v this becomes $y^2 + y + f = 0$ where $y = tv^{-k}$ with roots $y = \lambda_\pm$. The asymptotic positions of the NS5s are given by $t_\pm = \lambda_\pm v^k$. The space of UV gauge couplings of the theory is parameterised by the position of these roots. It is therefore $\mathcal{M}_{(2,2),0}$ the moduli space of 4 punctured spheres with two of the points distinct. The S-duality group is $\pi_1(\mathcal{M}_{(2,2),0}) = \tilde{\Gamma}_0(2)$. Collisions of the punctures correspond to the various cusps and fixed points of $\mathcal{F}(\tilde{\Gamma}_0(2))$.

3.1.6 Generalisation

The above analysis has an immediate generalisation to product gauge groups $\prod_{\alpha=1}^n SU(k_\alpha)$. A configuration of $n + 1$ NS5s with D4s between them but no semi infinite D4s is considered. The β function coefficient of each gauge group factor is $b_{0,\alpha} = -2k_\alpha + k_{\alpha+1} + k_{\alpha-1}$, $\sum_\alpha b_{0,\alpha} = -k_1 - k_n < 0$. In order for all the β functions to vanish one would need to add extra flavors at the first and last node of the quiver either through semi infinite D4s or D6s (see next section). In the absence of such extra flavors and

with the dynamically generated scale set to 1 the SW curve is given by

$$t^{n+1} + p_1(v)t^n + p_2(v)t^{n-1} \dots p_n(v)t + 1 = \prod_{\alpha=0}^n (t - t_\alpha(v)) = 0 \quad (3.16)$$

The asymptotic positions of the NS5s take a similar form to the previous case $t_\alpha(v) \sim h_\alpha v^{\delta_\alpha}$ where $\delta_0 \geq \delta_1 \geq \dots \geq \delta_n$, which labels the NS5s so that the α^{th} is to the right of the $\alpha - 1^{th}$. Relating these to the UV couplings

$$-i\tau_\alpha = s_\alpha - s_{\alpha-1} = \ln \frac{t_{\alpha-1}}{t_\alpha} = -b_{0,\alpha} \ln v + \text{constant} \quad (3.17)$$

gives $\delta_{\alpha-1} - \delta_\alpha = b_{0,\alpha}$. Proceeding via induction on α one can show

$$\delta_\alpha = k_{\alpha+1} - k_\alpha \quad (3.18)$$

which relates the asymptotic bending of an NS5s to the net D4 charge on it. Comparing with 3.16 the degree of $p_\alpha(v)$ are seen to be $\sum_{j=1}^{\alpha-1} \delta_j = k_\alpha$. Expanding $p_\alpha(v)$

$$p_\alpha(v) = c_{\alpha,0}v^{k_1} + c_{\alpha,1}v^{k_1-1} + \dots \quad (3.19)$$

One observes that the highest order coefficients are related to $h_\alpha \sim c_{\alpha+1,0}/c_{\alpha,0}$ which determine the constant in 3.17. The roots of $p_\alpha(v) = 0$ give positions of D4s associated to the α^{th} group factor and the bifundamental masses are given by

$$m_\alpha = \frac{1}{k_\alpha c_{\alpha,0}} c_{\alpha,1} - \frac{1}{k_{\alpha+1} c_{\alpha+1,0}} c_{\alpha+1,1} \quad (3.20)$$

If one includes semi infinite D4s at either end p_0 and p_n will be polynomials in v , their roots being the masses of the fundamentals they introduce. A more elaborate method to introduce fundamental matter is through the inclusion of D6 branes.

3.1.7 D6 Branes

As previously mentioned D6 branes can be added to the type IIA configuration and still preserve $\mathcal{N} = 2$ supersymmetry in $\mathbb{R}^{1,3}$. Strings stretched between D6s and D4s couple a hypermultiplet to the w.v. V-plet while strings between D6s and NS5s do not contribute. D4s can be stretched between a D6 and a NS5 but due to the differing boundary conditions at both ends they are non-dynamical. Thus placing d_α D6s between the $\alpha - 1^{th}$ and α^{th} NS5s couples d_α hypermultiplets to $SU(k_\alpha)$. The β function coefficient is modified to $-b_{0,\alpha} = 2k_\alpha - k_{\alpha+1} - k_{\alpha-1} - d_\alpha$. The Coulomb branch physics is actually independent of the x^6 position of the D6s. Figure 3.1.7 shows two equivalent systems related by a Hanany-Witten transition. When a D6 brane moves in the x^6 direction so that it crosses an NS5 it drags a D4 behind it. Alternatively a D4 between a D6 and an NS5 can be destroyed by the reverse process. Of the d D6s between the NS5s in 3.1.7 one can push any amount, say d_l , to $-\infty$ and the remainder, d_r to $+\infty$. This creates the d semi infinite D4s seen on the right of the figure. The gauge theory in both cases is $SU(k)$ with d flavors. This phase transition is realised in the SW curve via a simple rescaling of t . Equation 3.15 gives the SW curve with $2k$ flavors coming from semi infinite D4s to the right. Rescaling $t \rightarrow t \prod_{j=1}^{2k} (v - m_j)$ gives the curve for flavors coming from D4s to the left.

The M theory uplift of a D6 is a KK monopole which changes the flat 11d space-time to $\mathbb{R}^{1,6} \times Q$ where Q is now a Taub-NUT space. The metric for this is known but it will be easier to work with one of its complex structures instead.

The full brane configuration will lift to an M5 brane with w.v. $\mathbb{R}^{1,3} \times \Sigma$ with $\Sigma \subset \tilde{Q}$ a multi centre Taub-NUT space. \tilde{Q} can be embedded in \mathbb{C}^3 with \mathbb{C} coordinates (y, z, v)

$$yz = P(v) = \prod_{a=1}^d (v - e_a) \quad (3.21)$$

where $e_a, a = 1, \dots, d$ are the v positions of the D6s. This is independent of x^6 positions but as mentioned above so is the Coulomb branch. For $d = 0$ reduces to $yz = 1$ and $y = t, z = t^{-1}$. Taub-NUT space is asymptotically flat implying $y = t, z = t^{-1}$ is the

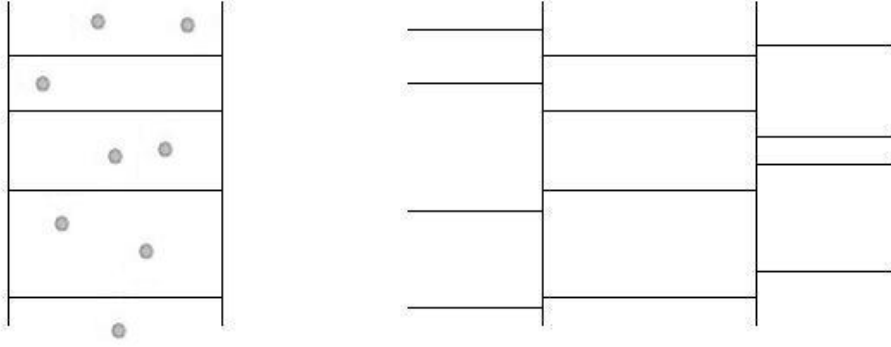

Figure 3-5: This figure depicts two different brane configurations related by a Hanany-Witten transition. On the left the X s represent D6s. These can be pushed to the left or the right. When they cross an NS5 they drag a D4 behind them. If they are then brought out to $\pm\infty$ they configuration is the one on the right with semi infinite D4s instead of D6s.

large v behaviour.

Again starting with the $n = 1$ case with k D4s $F(y, v) = A(v)y^2 + B(v)y + C(v)$. No semi infinite D4s means no solution for $y \rightarrow \infty$ and $y = 0$ or $z \rightarrow \infty$. The first condition is satisfied by $A(v) = 1$. The second, after a change of coordinates $z = P(v)/y$,

$$C(v)z^2 + B(v)z + P(v)^2 = 0 \quad (3.22)$$

requires $C|BP$, $C|P^2$. The zeros of $C(v)$ are thus $v = e_a$ with multiplicities 0,1 or 2. Writing

$$C(v) = f \prod_{a=1}^{i_0} (v - e_a)^2 \prod_{b=i_0+1}^{i_1} (v - e_b) \quad (3.23)$$

implies

$$B(v) = \tilde{B}(v) \prod_{a=1}^{i_0} (v - e_a) \quad (3.24)$$

and after rescaling $y \rightarrow y \prod_{a=1}^{i_0} (v - e_a)$ F is

$$y^2 + \tilde{B}(v)y + f \prod_{a=i_0+1}^{i_1} (v - e_a) = 0 \quad (3.25)$$

which matches the curve for $SU(k)$ with $i_1 - i_0$ flavors (c.f. 3.15). Of the d D6s initially introduced only $i_1 - i_0$ are apparent, those located at e_a , $a \leq i_0$ and $a > i_1$ are interpreted as being to the right and left of the configuration respectively. Their physics decouples from the main system.

3.1.8 Generalisation

The curve for $n + 1$ NS5s, $\sum_{\alpha=1}^n k_\alpha$ D4s and d D6s is

$$A_0(v)y^{n+1} + A_1(v)y^n + \dots A_{n+1} = 0 \quad (3.26)$$

Having no semi infinite D4s fixes $A_0 = 1$ and that $A_{n+1}|P^{n+1-\alpha}A_\alpha$, the zeros of A_{n+1} are also zeros of $P(v)$ this time with multiplicities at most $n + 1$.

$$A_{n+1} = \prod_{a=1}^{i_0} (v - e_a)^{n+1} \prod_{i_0+1}^{i_1} (v - e_a)^n \dots \prod_{i_{n-1}+1}^{i_n} (v - e_a) \quad (3.27)$$

as before after rescaling $y \rightarrow y \prod_{a=1}^{i_0} (v - e_a)$ gives the SW curve

$$y^{n+1} + p_1(v)y^n + p_2(v)J_1(v)y^{n-1} + p_3(v)J_1^2(v)J_2(v)y^{n-2} + \dots + f \prod_{s=1}^n J_s^{m+1-s} = 0 \quad (3.28)$$

where $J_s = \prod_{a=i_{s-1}+1}^{i_s} (v - e_a)$. Again D6s at e_a , $a \leq i_0$ and $a > i_{n+1}$ do not appear. They are the v positions of D6s to the right and left, respectively, of the configuration. Further i_α is the total number of D6s to the left of the α^{th} NS5 and $d_\alpha = i_\alpha - i_{\alpha-1}$.

Each β function can be made to vanish by an appropriate choice of d_α , $d_\alpha = 2k_\alpha - k_{\alpha+1} - k_{\alpha-1}$. The degree in v of $p_m(v)$, the coefficient of y^{n+1-m} , is

$$k_m + \sum_{s=1}^{m-1} (m-s)d_s = mk_1 \quad (3.29)$$

When all β functions vanish. For large v in terms of $x = yv^{-k_1}$

$$x^{n+1} + c_{1,0}x^n + \dots + c_{n,0}x + f = 0 \quad (3.30)$$

The $c_{\alpha,0}$ and f parametrise the UV coupling space $\mathcal{M}_{(n+1,2),0}$, the moduli space of an $n + 3$ punctured sphere where two of the punctures are marked and $n + 1$ are unmarked. The S-duality group is $\pi_1(\mathcal{M}_{(n+1,2),0})$. S-duality permutes the unmarked punctures and collisions of punctures correspond to various weak and strong coupling limits of the theory. One can see through the M-theory picture that $\pi_1(\mathcal{M}_{(n+1,2),0})$ is the exact S-duality group rather. This could also be seen without recourse to M theory via an embedding in a larger asymptotically free as described at the end of chapter 2, [15].

Any of the gauge group factor can be Higgsed or decoupled. To Higgs a group factor one chooses an NS5 and forces the D4s to either side to line up and recombine. The NS5 can then be made move away in x^μ , $\mu = 7, 8, 9$. Decoupling a group factor corresponds to moving the two NS5s associated to that factor so that their separation diverges. For example the first factor can be decoupled by $t_0 \rightarrow \infty$.

3.1.9 Elliptic Models

This section explores models in which x^6 is compactified on S^1 . It will turn out that with this modification of the initial setup one can re derive the curves for $\mathcal{N} = 4$ theories, as well as other interesting theories.

The compactification identifies branes ending to the left of the first NS5 and to the right of the last. Thus what were fundamental hypers coupled to the first and last group factors are now bifundamentals in the (k_1, \bar{k}_n) representation. The quiver diagram is the extended A_n Dynkin diagram. In addition

$$\sum_{\alpha} m_{\alpha} = \frac{1}{k} \sum_{\alpha} \left(\sum_i a_{i,\alpha} - \sum_j a_{j,\alpha+1} \right) = 0 \quad (3.31)$$

the global mass vanishes. Setting $k_0 = k_n$, $k_{n+1} = k_1$ we see that

$$\sum_{\alpha} b_{0,\alpha} = -k_1 - k_n + k_0 + k_{n+1} + \sum_{\alpha} d_{\alpha} = \sum_{\alpha} d_{\alpha} \geq 0 \quad (3.32)$$

To have non positive β functions, $d_\alpha = 0, \forall \alpha$ which implies $b_{0,\alpha} = 0, \forall \alpha$

$$0 = \sum_{\alpha} k_{\alpha} b_{0,\alpha} = - \sum_{\alpha} (k_{\alpha} - k_{\alpha-1})^2 \Rightarrow k_{\alpha} = k, \forall \alpha \quad (3.33)$$

The full gauge group is actually $G = U(1) \times SU(k)^n$. The extra $U(1)$ is present because the condition imposed by 3.4 can only ‘freeze’ $n - 1$ $U(1)$ s, physically the remaining abelian group factor is the centre of mass motion along the x^6 direction. It decouples from the rest of the physics and so will be ignored in what follows. The case of $n = 1$ is of particular interest. There is only one NS5 with a single hyper in the (k, \bar{k}) rep which is the adjoint. The vanishing of the global mass means the theory has $\mathcal{N} = 4$ supersymmetry. A non zero global mass can be introduced via a certain topological twist of the spacetime. For elliptic models (v, x^6) are coordinates in $T = \mathbb{C} \times S^1$ which is obtained by the identification $x^6 \rightarrow x^6 + 2\pi L$. If instead one simultaneously identifies

$$x^6 \rightarrow x^6 + 2\pi L \quad (3.34)$$

$$v \rightarrow v + m \quad (3.35)$$

for m constant, T becomes a non trivial affine \mathbb{C} bundle over S^1 . The overall effect of this twist is to allow a non vanishing global mass $\sum_{\alpha} m_{\alpha} = m$.

The M theory spacetime requires two identifications $x^6 \rightarrow x^6 + 2\pi L, x^{10} \rightarrow x^{10} + 2\pi R$. This results in $Q = E_{\tau} \times \mathbb{C}$, where E_{τ} is a torus with complex parameter τ (the appearance of this elliptic curve is where these models derive their name from). The second identification fixes the global θ parameter to vanish, $\sum_{\alpha} \theta_{\alpha} = \sum_{\alpha} (x_{\alpha}^{10} - x_{\alpha-1}^{10}) / R = 0$. The following simultaneous identifications however allow for both non vanishing global mass and θ parameter

$$x^6 \rightarrow x^6 + 2\pi L \quad (3.36)$$

$$x^{10} \rightarrow x^{10} + \theta R \quad (3.37)$$

$$v \rightarrow v + m \quad (3.38)$$

The further identification $x^{10} \rightarrow x^{10} + 2\pi R$ gives the appropriate M theory spacetime $\mathbb{R}^{1,3} \times Q_m \times R^3$. Where the product space Q is replaced by a non trivial affine \mathbb{C} bundle over E_τ , denoted Q_m . The SW curve, $\Sigma \subset Q_m$

We begin the analysis of the solutions of such models with the case of $m = 0$. There are k D4s between each pair of NS5s, which can be viewed as a deformation of k D4s wrapping E_τ spanning the n NS5s. In this way one can interpret Σ as the k -fold cover of E_τ . More precisely the projection $\pi : Q_0 \rightarrow E_\tau$ maps $\Sigma \rightarrow E_\tau$ with the fibre of this map being $\{v_i\}$. As it is a k -fold cover of E_τ , Σ has the form

$$\Sigma : v^{k+1} + f_1(x, y)v^k + \dots + f_k(x, y) = \prod_{i=1}^k (v - v_i(x, y)) = 0 \quad (3.39)$$

$$E_\tau : y^2 = (x - e_1(\tau))(x - e_2(\tau))(x - e_3(\tau)) \quad (3.40)$$

(c.f. Taub-NUT embedding of Σ , 3.21) where $f_i(x, y)$ are meromorphic functions on E_τ . They have simple poles at the locations of the n NS5s and the residues of the differential $f_1(x, y)\frac{dx}{y}$ are the mass parameters of the bifundamentals, as it is a meromorphic function the sum of these residues must be zero. The other $f_i(x, y)$ encode the Coulomb branch parameters.

The spacetime twist $v \rightarrow v + m$ requires a modification 3.39. Here we simply state the conditions that the curve must now satisfy, which were derived in [19]. Away from the point $x = y = \infty$ 3.39 is still a valid description of the SW curve. At infinity one must make a change of coordinates to w, z, \tilde{v}

$$x = w^{-2}, \quad y = zw^{-3}, \quad \tilde{v} = v + \frac{my}{2kx} \quad (3.41)$$

In terms of these coordinates the SW curve at infinity is

$$\tilde{v}^k + \tilde{f}_1(z, w)\tilde{v}^{k-1} + \dots + \tilde{f}_k(z, w) = 0 \quad (3.42)$$

$\tilde{f}_i(z, w)$ are meromorphic functions which can have poles of order at most i at $u = 0$. The global mass parameter m is the residue of $f_1(x, y)$ at infinity.

3.1.10 Coupling Space

As always the gauge couplings of the theory are given by the separation of the NS5s in (x^6, x^{10}) i.e. by their position in E_τ . One can change the couplings not only by moving the NS5s in E_τ but also by varying the complex parameter τ of E_τ ². Thus the space of gauge coupling is $\mathcal{M}_{n,1}$, the moduli space of a genus 1 Riemann surface with n indistinguishable punctures. The duality group is then given by $\pi_1(\mathcal{M}_{n,1})$. For $n = 1$ $\pi_1(\mathcal{M}_{1,1}) = SL(2, \mathbb{Z})$ as expected for the $\mathcal{N} = 4$ theory.

3.2 Orientifolds and Symplectic and Orthogonal Groups

The previous section derived curves for unitary gauge groups only. Extending this to the SO and Sp series requires placing orientifold planes in the type IIA configuration. Orientifolds are non dynamical branes with R-R charge and tension and are the fixed plane of a spacetime \mathbb{Z}_2 orbifold. There are two ways of introducing orientifolds while still preserving the $\mathcal{N} = 2$ supersymmetry; an orientifold 4-plane, $O4$, positioned parallel to the D4s or an orientifold 6-plane, $O6$, parallel to the D6s. Depending on the R-R charge of the orientifold an orthogonal or symplectic gauge group appears on the w.v. of a stack of branes placed parallel to it.

3.2.1 Orientifold 4-planes

An $O4$ plane is placed at the origin of $x^\mu, \mu = 4, 5, 7, 8, 9$ spanning $\mathbb{R}^{1,3}$ and x^6 . The $O4$ is the fixed plane of $v \rightarrow -v, (x^7, x^8, x^9) \rightarrow -(x^7, x^8, x^9)$. The charge of an $O4$ can be ± 1 in D4 units, negative and positively charged planes are denoted $O4^-, O4^+$.

An $O4^-$ parallel to a stack of D4s projects an orthogonal gauge group onto their w.v. while an $O4^+$ will give a symplectic gauge theory. If there are D6s present an $O4$ will have the opposite effect on their w.v.. An $O4^-$, for instance, will project a

² τ is fixed by the constants θ and L and is related to the gauge couplings by $\sum_\alpha \tau_\alpha \propto \tau$. Thus the complex parameter of E_τ is the coupling of a diagonal subgroup of $G = SU(k)^n$

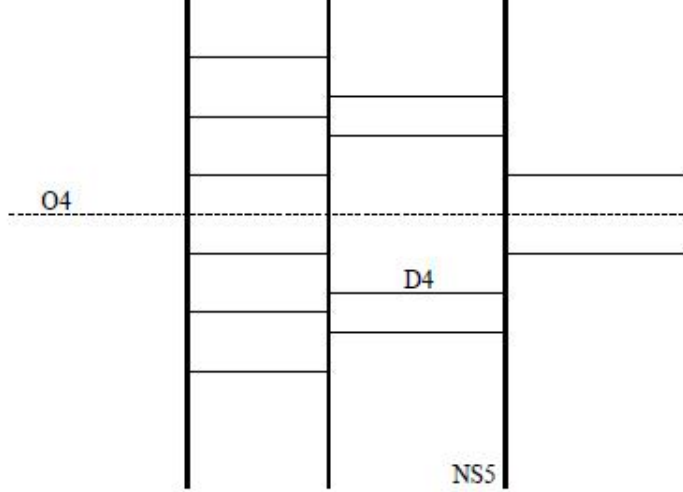

Figure 3-6: The double cover of a spacetime including an $O4$ and three NS5s plus their mirrors. The gauge group is either $S(6) \times Sp(4)$ or $Sp(6) \times SO(4)$ depending on the sign of the $O4$ to the left (this figure is taken from [24])

symplectic gauge group on a stack of D6s, this is consistent with the known flavor symmetry of orthogonal and symplectic gauge groups. For k D4s in the presence $O4^-$ and d D6s the resulting 4d theory is $SO(2k)$ coupled to d hypers transforming as $2d$ half hypers in the vector of $Sp(2d)$.

Figure 3.2.1 depicts the double cover of a configuration of $n + 1$ NS5s with k_α D4s between each pair (plus their mirror branes) in the presence of an $O4^-$. The α^{th} group factor is $SO(2k_\alpha)$ coupled to $k_{\alpha-1} + k_{\alpha+1}$ hypers. The flavor symmetry of this group factor is symplectic thus neighbouring group factors must be $Sp(k_{\alpha\pm 1})$. The orientifold changes charge when it crosses the NS5, becoming an $O4^+$. The actually gauge group is $G = \dots \times SO(2k_{\alpha-1}) \times Sp(2k_\alpha) \times SO(2k_{\alpha+1}) \times \dots$ as opposed to the naive $\prod SO(2k_\alpha)$. To begin with we look at the simple cases of 2 NS5s and derive the SW curves for $SO(2k)$, $SO(2k + 1)$ and $Sp(2k)$.

3.2.2 $SO(2k)$

k D4s (plus mirrors) suspended between two NS5s, parallel to an $O4^-$ plane will give a pure $SO(2k)$ gauge theory. The M theory curve, Σ_{SO} , should be invariant under the spacetime orbifold $v \rightarrow -v$ and reflect the fact that for every D4 at $v = a_i$ there

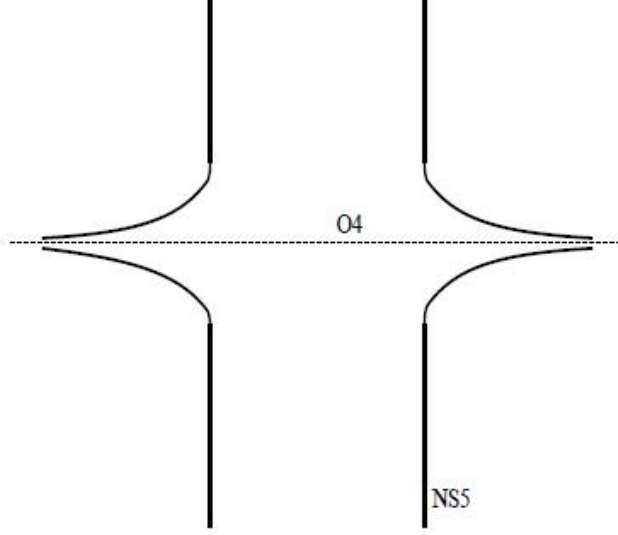

Figure 3-7: The geometry of a pair of NS5s near an $O4$ plane. the left NS5 has net D4 charge -2 due to the $O4$ while the right has +2(this figure is taken from [24]).

is a mirror D4 at $v = -a_i$. This leads to

$$A(v^2)t^2 + B(v^2)t + C(v^2) = 0 \quad (3.43)$$

The net D4 charge on the first NS5 due to the orientifold is +2, to the right of this NS5 the orientifold is an $O4^-$ and to the left a $O4^+$. Similarly the second NS5 has -2 net charge due to the orientifold. The asymptotic bending of the NS5s means that for large v 3.43 must have solutions

$$t_1 \sim v^{2k-2}, \quad t_2 \sim v^{-(2k-2)} \quad (3.44)$$

(there are $2k$ D4s ending on each NS5 including mirrors). The NS5s are unaffected by the spacetime orbifold. They feel the effect of the $O4$ only through the induced D4 charge on them. Near the $O4$, the M5 geometry is determined by this charge, the first NS5 is bent $t \rightarrow \infty, x^6 \rightarrow -\infty$ as $v \rightarrow 0$ and while the second is $t \rightarrow 0, x^6 \rightarrow -\infty$, see figure 3.2.1. 3.43 must have solutions $t = 0, \infty$ for $v = 0$. Incorporating these two conditions gives

$$v^2 t^2 + B(v^2)t + v^2 \Lambda^{4k-4} = 0 \quad (3.45)$$

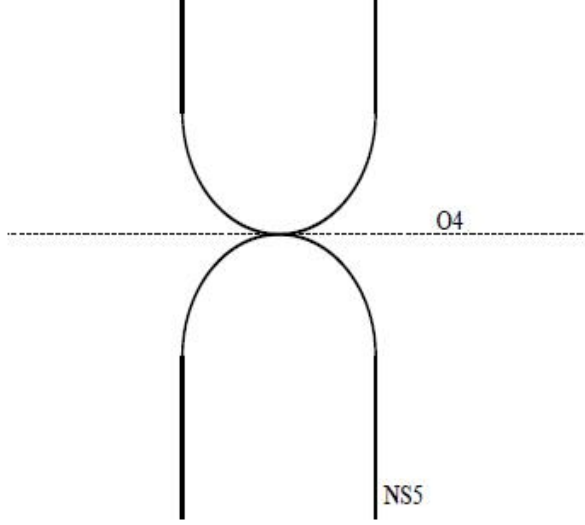

Figure 3-8: The near $O4$ geometry of a pair of NS5s for a symplectic gauge group (this figure is taken from [24]).

where $B(v^2)$ is degree $2k$ in v . After a rescaling $v^2 t \rightarrow t - B/2$ to get rid of the term linear in t , the SW curve is reproduced.

$$t^2 = \frac{B(v^2)^2}{4} - v^4 \Lambda^{4k-4}, \quad B(v^2) = v^{2k} + u_2 v^{2k-2} + \dots + u_{2k} \quad (3.46)$$

One can cure the $v \rightarrow 0$ NS5 bending by moving a D4, plus its mirror to lie on the $O4^-$. This cancels the orientifold charge. In the gauge theory this corresponds to setting $u_{2k} = 0$. After dividing out by v^2 (3.46) no longer has solutions $t = 0, \infty$.

3.2.3 $Sp(2k)$

Swap the $O4^-$ in the previous set up for an $O4^+$ and the resulting theory is pure $Sp(2k)$. The net D4 charges induced by the $O4$ on the NS5s are changed by this replacement. The asymptotic bending takes a similar form

$$t_1 \sim v^{2k+2}, \quad t_2 \sim v^{-(2k+2)} \quad (3.47)$$

The near $O4$ geometry of the NS5s is completely different however, the net charge induced on the first NS5 by the $O4$ is now $+2$ while for the second it is -2 . These

changes force the NS5s to bend towards one another rather than away. They reach an equilibrium at the point where they touch. At this point each NS5 is flanked by an $O4^-$ giving zero net charge and thus preventing any further bending see figure 3.2.2. The upshot of for Σ_{Sp} is that there are no solutions for $t = 0, \infty$ but a double zero at $v = 0$ (where the NS5s touch). Σ_{Sp} is thus described by

$$t^2 + (v^2 B(v^2) - 2\Lambda^{2k+2})t - \Lambda^{4k+4} = 0 \quad (3.48)$$

with $B(v^2)$ degree $2k$ in v . A shift $t \rightarrow t + v^2 B(v^2)/2$ gives

$$t^2 = \frac{(v^2 B(v^2) - 2\Lambda^{2k+2})^2}{4} - \Lambda^{4k+4} \quad (3.49)$$

the SW curve for $Sp(2k)$.

3.2.4 $SO(2k+1)$

An odd number of D4s (including mirrors) can be facilitated if one of the D4s is forced to lie on the $O4^-$. This reduces the induced charges to be -1 for the first NS5 and +1 for the second. The two NS5s still bend away from each other but the asymptotic bending is different

$$t_1(v) \sim v^{2k-1}, \quad t_2 \sim v^{-(2k-1)} \quad (3.50)$$

$\Sigma_{SO(2k+1)}$ is given by

$$vt^2 + B(v^2)t + v\Lambda^{4k-2} = 0 \quad (3.51)$$

Again a shift of $t \rightarrow vt - B/2$ brings 3.51 to the familiar form

$$t^2 = \frac{B(v^2)^2}{4} - v^2 \Lambda^{4k-2} \quad (3.52)$$

The $v \rightarrow 0$ bending can this time not be cured. Moving a D4 and its mirror to lie on the $O4^-$ causes the NS5s to bend inward instead.

3.2.5 Adding D4 Flavor

Semi infinite D4s can be attached to either side of the configuration to couple hypers to the theory. The curves for $SO(2k)$ and $SO(2k + 1)$ are modified in the usual fashion, $A(v^2)$ and $C(v^2)$ have roots at the D4 positions. With $N_{L,R}$ D4s to the left and right of the initial setup and $\Lambda = 1$ for convenience

$$\Sigma_{SO(2k)} : v^2 t^2 \prod_{i=1}^{N_L} (v^2 - m_i^2) + B(v^2)t + v^2 \prod_{j=1}^{N_L} (v^2 - m_j^2) = 0 \quad (3.53)$$

$$\Sigma_{SO(2k+1)} : vt^2 \prod_{i=1}^{N_L} (v^2 - m_i^2) + B(v^2)t + v \prod_{j=1}^{N_L} (v^2 - m_j^2) = 0 \quad (3.54)$$

For $Sp(2k)$ the double zero condition must be enforced after the extra flavor is added, e.g. for N_R and N_L D4s to the right and left, $N_L + N_R < 4k$ Σ_{Sp} is given by

$$\Sigma_{Sp} : t^2 \prod_i^{N_L} (v^2 - m_i^2) + (B(v^2)t - c) + \prod_j^{N_R} (v^2 - m_j^2) = 0 \quad (3.55)$$

a double zero at $v = 0$ implies

$$c = 2(-1)^{(N_R+N_L)/2} \prod_i^{N_L} \prod_j^{N_R} m_i m_j \quad (3.56)$$

The semi infinite D4s must appear in pairs at \mathbb{Z}_2 symmetric locations. A single D4 to either side can be added on top of the $O4^-$, this however will couple a half hyper to the theory, breaking the supersymmetry to $\mathcal{N} = 1$ at least.

The theory $SO(2k)$ coupled to $2k - 2$ hypers transforming as half hypers in the vector of $Sp(4k - 4)$ has vanishing β function. It is constructed by adding $k - 1$ semi infinite D4s plus their mirrors to both sides of the $SO(2k)$ configuration. At large v the curve reduces to

$$t^2 + t + f = 0 \quad (3.57)$$

The solutions govern the large v positions of the NS5s. The coupling space is thus $\mathcal{M}_{(2,2),0}$ with S-duality group $\pi_1(\mathcal{M}_{(2,2),0}) = \tilde{\Gamma}_0(2)$

3.2.6 Generalisation

Generalising to a system of $n + 1$ NS5s with k_α D4s between each pair, the gauge group is an alternating product of orthogonal and symplectic groups. The matter content will be $n + 1$ sets of half hypers transforming as $(2k_\alpha, 2k_{\alpha+1})$. The asymptotic behaviour of the NS5s is

$$t_\alpha(v) \sim v^{2k_{\alpha+1} - 2k_\alpha - 2\omega_\alpha} \quad (3.58)$$

where the ω_α is the charge of the $O4$ to the right of the α^{th} NS5. ω_0 is the charge of the left most section of the $O4$. If $\omega_0 = 1$ or $1/2$ the first group factor is SO and Sp when $\omega_0 = -1$. The general form for the M theory curve is

$$P_0(v^2)t^{n+1} + P_1(v^2)t^n + \dots + P_n(v^2) = P_0(v^2) \prod_{\alpha=1}^{n+1} (t - t_\alpha(v^2)) = 0 \quad (3.59)$$

Using the same analysis as below 3.18 one sees that the degree of $P_i(v^2)$ denotes p_i satisfies

$$p_i - \sum_{\alpha=1}^{i-1} \delta_\alpha + p_0 = 2k_i - (1 - (-1)^i)\omega_0 + p_0 \quad (3.60)$$

Matching these to the curves for single gauge groups gives $p_0 = 2$ for a first factor of $SO(2k_1)$, $p_0 = 0$ for $Sp(2k_1)$ and $p_0 = 1$ for $SO(2k_1 + 1)$. First consider groups $\dots \times SO(2k_\alpha) \times Sp(2k_{\alpha+1}) \times \dots$. There are four cases corresponding to $\omega_0 = \pm 1$, $n + 1$ odd or even. If $n + 1$ is even the first and last group factors are the same and different if $n + 1$ is odd. For example, $n + 1$ odd and $\omega_0 = -1$ result in a curve of the form

$$t^{n+1} + (v^2 B_1(v^2) + c_1) t^n + B_2(v^2) t^{n-1} + \dots + (v^2 B_n(v^2) + c_n) t + v^2 + c_{n+1} = 0 \quad (3.61)$$

B_i are the usual degree $2k_i$ polynomials governing the Coulomb branch of the i^{th} group factor. The c_k are determined by the near $O4$ geometry of the NS5s, there must be $n/2$ double zeros at $v = 0$ and a solution at $t = 0$ (the last group factor is

$SO(2k_n)$). At $v = 0$

$$t^{n+1} + c_1 t^n + u_{2k_2}^{(2)} t^{n-1} + \dots + u_{2k_n}^{(n)} + c_{n+1} = 0 \quad (3.62)$$

$c_{n+1} = 0$ so as to ensure a $t = 0$ solution. The c_k are thus determined in terms of $u_{2k_i}^{(1)}$ by

$$t^n + c_1 t^{n-1} + u_{2k_2}^{(2)} t^{n-2} + \dots + u_{2k_n}^{(n)} = \prod_{i=1}^{n/2} (t - t_i(v^2))^2 \quad (3.63)$$

One can also have $\dots \times SO(2k_\alpha + 1) \times Sp(2k_{\alpha+1}) \times \dots$. This requires one to place an unpaired D4 on top of every $O4^-$ section. In the process a half hyper is coupled to the adjacent Sp gauge groups. The only way for such a configuration to preserve the $\mathcal{N} = 2$ supersymmetry is for every Sp group to be sandwiched between two orthogonal groups so that $Sp(2k_\alpha)$ is coupled to $2k_\alpha + 2k_{\alpha+1} + 2$ half hypers. $n + 1$ must be even for product groups involving $SO(2k + 1)$ factors.

3.2.7 D6s

Just as for configurations without orientifolds D6s can be introduced to couple fundamental matter to the group factors. The M theory curve Σ is embedded in a multi centre Taub-NUT space. First we tackle the $n = 1$ case with d D6s plus mirrors in an $O4^-$ background. The gauge theory is $SO(2k)$ with d' hypers transforming as $2d'$ half hypers in the vector of $Sp(2d')$

$$\Sigma : \quad v^2 y^2 + B(v^2) y + v^2 C(v^2) = 0 \quad (3.64)$$

$$\tilde{Q} : \quad yz = P(v^2) = \prod_{a=1}^d (v^2 - e_a^2) \quad (3.65)$$

Applying the conditions $C|BP$, $C|P^2$ and rescaling appropriately

$$v^2 y^2 + B(v^2) y + f v^2 \prod_{a=i_0+1}^{i_1} (v^2 - e_a^2) \quad (3.66)$$

which is the same as 3.53 with $N_L = 0$, $n_R = i_1 - i_0$. Similarly 3.53 and 3.55 can be reproduced using D6s. Including D6s in $n > 1$ models follows the same construction as unitary gauge groups. For example in the case of $SO(2k_1) \times \cdots \times SO(2k_n)$, Σ is given by

$$y^{n_1} + p_1(v^2)y^n + p_2(v^2)J_1(v^2) + \cdots + f + \prod_{s=1}^n J_s^{n+1-s} = 0 \quad (3.67)$$

where $J_s = \prod_{a=i_{s-1}+1}^{i_s} (v^2 - e_a^2)$, $d_\alpha = i_\alpha - i_{\alpha-1}$. The extra constants for Sp groups are determined as before by the near $O4$ geometry.

3.2.8 Elliptic Models

The ‘unfrozen’ $U(1)$ appearing in the gauge group for unitary elliptic models does not appear in an orientifold background. The $U(1)$ is related to a c.o.m motion of the entire system. An orientifold however is non dynamical and thus precludes such motion. The additional D4 charge induced on the NS5s due the $O4$ changes the condition for vanishing β functions. WLOG the first factor can be taken to be $SO(2k_1)$ so that the asymptotic bending of the NS5s is

$$t_1 \sim v^{2k_1-2k_n-2}, \quad t_2 \sim v^{2k_2-2k_1+2}, \quad t_3 \sim v^{2k_3-2k_2-2}, \dots \quad (3.68)$$

implying $G = SO(2k) \times Sp(2k-2) \times \cdots \times SO(2k) \times Sp(2k-2)$.

The topological twist previously introduced to give non vanishing global parameters is not compatible with the orientifold projection, $v = 0$ would not be invariant $\Rightarrow Q = E_\tau \times \mathbb{C}$ the straightforward product space. We would like to interpret Σ as a $2k$ -fold cover of E_τ . How could this be however when the number of D4s between each pair of NS5s alternates between $2k$ and $2k-2$. The answer is that even though the Sp factors are associated to $2k-2$ D4s the polynomial governing their position is degree $2k$. Thus the $2k$ -fold cover of E_τ given by

$$\Sigma : \quad v^{2k} + f_1(x, y)v^{2k-2} + \cdots + f_k(x, y) = 0 \quad (3.69)$$

$$E_\tau : \quad y^2 = (x - e_1(\tau))(x - e_2(\tau))(x - e_3(\tau)) \quad (3.70)$$

is the appropriate description of Σ . The $f_i(x, y)$ are meromorphic functions E_τ with the same properties and singularity structure as for unitary models.

3.2.9 Orientifold 6-planes

The use of $O6$ planes to produce orthogonal and symplectic gauge groups is more complicated than the case of $O4$ s, it will however give curves involving non fundamental matter and different product groups as well. The complication arises when one tries to lift an $O6$ to M theory, just as for D6s an $O6$ will lift to a non trivial M theory spacetime. For an $O6^-$ this is an Atiyah-Hitchin space while the exact spacetime for an $O6^+$ is not known. To embed an M theory curve in these spaces we use the following (c.f. 3.21)

$$\tilde{Q}_+ : \quad yz = v^4 \tag{3.71}$$

$$\tilde{Q}_- : \quad yz = v^{-4} \tag{3.72}$$

The first is motivated by noticing that far away from an $O6^+$ it should look like four coincident D6s. The second is a complex structure of the Atiyah-Hitchin space. The $O6$ s will be located at $v = 0$, $x^6 = 0$ and induce a spacetime projection $v \rightarrow -v$, $x^6 \rightarrow -x^6$. Placing the usual type IIA configuration to the right of an $O6^+$ will give group of the form $G = SO(N) \times \prod SU(k_i)$ and $G = Sp(N) \times \prod SU(k_i)$ if an $O6^-$ is used instead.

3.68 can be checked by rederiving the curves for a single SO and Sp group. To do this consider 2 NS5s and $2k$ D4s including mirrors in an $O6^+$ background. The general 2 NS5 curve 3.11 is modified by $yz = v^4$ to give the conditions $C|v^8, C|B(v)v^8$ which along with invariance under $v \rightarrow -v$ furnishes two solutions

$$\text{I:} \quad C(v) = v^4, \quad B(v) = B(-v) = B(v^2) \tag{3.73}$$

$$\text{II:} \quad C(v) = v^{-4}, \quad B(v) = -B(-v) = v\tilde{B}(v^2) \tag{3.74}$$

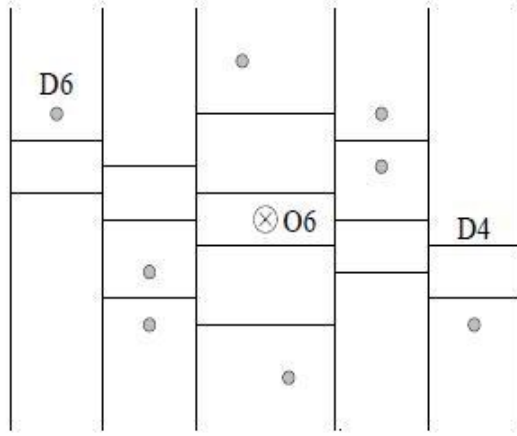

Figure 3-9: Configuration of NS5s, D4s and D6s arranged symmetrically with respect to an $O6$ (this figure is taken from [25]).

choosing I or II, Σ is

$$\text{I: } y^2 + B(v^2)y - v^4 = 0 \quad (3.75)$$

$$\text{II: } y^2 + v\tilde{B}(v^2)y - v^4 = 0 \quad (3.76)$$

which related to 3.46 and 3.52 respectively via a shift in y . If an $O6^-$ were to be included instead Σ is

$$y^2 + y(v^2B(v^2) + Av^{-2}) + v^{-4} = 0 \quad (3.77)$$

Note that now negative powers of v appear, this is a consequence of 3.68 not describing an Atiyah-Hitchin space at small v . Away from the $O6^-$, one can rescale $y \rightarrow yv^{-2}$ and obtain the curve for $Sp(2k)$ upon setting $A = -2$.

3.2.10 Generalisation

Figure 3.2.9 depicts n NS5s with k_α D4s and d_α D6s between each pair plus their mirrors. The spacetime \mathbb{Z}_2 orbifold implies $k_i = k_{2n-i}$, $d_i = d_{2n-i}$ the two NS5s abreast of the $O6$ will produce a single SO or Sp group the other pairs contribute

$SU(k_i)$ to the product while the \mathbb{Z}_2 serves to identify $SU(k_i) \sim SU(k_{2n-i})$. The full group is $\prod_{i=1}^{n-1} SU(k_i) \times SO(k_n)$, k_n even or odd for an $O6^+$ and $\prod_{i=1}^{n-1} SU(k_i) \times Sp(k_n)$. The matter content is $n-1$ hypers in bifundamentals $(k_\alpha, \overline{k_{\alpha+1}})$, $\alpha = 1, \dots, n-1$, d_α hypers in the fundamental of $SU(k_\alpha)$ and $d_n/2$ in the vector of $SO(k_n)$. To describe both D6s and an $O6^+$ requires embedding in the space

$$yz = P(v) = (-1)^d v^4 \prod_{i=1}^{2d} (v - m_i) \quad (3.78)$$

where $2d = \sum_i d_i$. Using the same techniques as the previous D6 cases one obtains the M theory curve

$$y^{2n} + g_1(v)y^{2n-1} + \dots + g_i \prod_{s=1}^{i-1} J_s^{i-s} y^{2n-i} + \dots + f \prod_{s=1}^{2n-1} J_s^{2n-s} = 0 \quad (3.79)$$

where $J_s(v) = c_s \prod_{i=s-1+1}^{i_s} (v - m_j)$, subject to $J_s(v) = J_{2n-s}(-v)$ and $c_s = 1, s = 1, \dots, n-1$, $c_n = (-1)^{d_n/2} v^4$, $c_s = (-1)^{d_s}, s = n+1, \dots, 2n-1$. The spacetime orbifold introduced by the orientifold acts as $(v, y, z) \rightarrow (-v, z, y)$ and for 3.77 to be invariant under this gives two possible solutions

$$\text{I: } f = 1, \quad g_i(v) = g_{2n-i}(-v) \quad (3.80)$$

$$\text{II: } f = -1, \quad g_i(v) = -g_{2n-i}(-v) \quad (3.81)$$

Option I corresponds to k_n even and II to k_n odd. Note that this brane configuration can only make manifest an $SU(k_{n-1}) \subset Sp(2k_{n-1})$ of the flavor symmetry for the SO group factor. The adjacent pair of NS5s contribute an $SU(k_{n-1})$ as opposed to $Sp(2k_{n-1})$ that would be required.

3.2.11 $SU(N)$ with symmetric and anti-symmetric matter

Three NS5s including mirrors arranged symmetrically with respect to the $O6$ will result in an $SU(N)$ theory coupled to matter in a two index representation. The unpaired NS5 must be at $v = 0$ with the N D4s suspended between it and the NS5s

to its left and to its right, each stack having an $SU(N)$ w.v. theory. The orientifold causes these two groups to be identified implying the actual gauge group is a single $SU(N)$ and the matter is a single hyper in a two index rep of this group. There are not enough degrees of freedom available for this to form an adjoint and so it must be either the symmetric or antisymmetric. Which of the two it is depends on the charge of the $O6$.

First choose an $O6^+$, 3.77 generalises to

$$y^3 + y^2 \prod_{i=1}^N (v - a_i) + (-1)^N y v^2 \prod_{j=1}^N (v + a_j) + v^6 = 0 \quad (3.82)$$

One might expect that due to the nature of the $O6^+$ projection on a stack of D4s that the representation would be symmetric. To show this explicitly, recall that the curve ?? must exhibit invariance under the unbroken discrete R-symmetry, \mathbb{Z}_{b_0} . Assigning charge N to y and 1 to v one sees that $b_0 = N - 2$. Matching to the general equation for the β function coefficient $b_0 = 2N - 2I_m$ gives the index of the rep as $I_m = (N + 2)/2$. The matter is in the 2 index symmetric representation.

Using an $O6^-$ will result in antisymmetric matter. To confirm this, one again examines the \mathbb{Z}_{b_0} invariance of the M theory curve.

$$y^3 + y^2(p(v) + Bv^{-1} + Av^{-2}) + v^{-2}y(q(v) - Bv^{-1} + A^{-2}) + v^{-6} = 0 \quad (3.83)$$

$p(v) = q(-v) = \prod_{i=1}^N (v - a_i)$ and A, B constants. Setting $\Lambda = 1$ one sees $b_0 = N + 2 \Rightarrow I_m = (N - 2)/2$, the index of the antisymmetric. The constants can be fixed by requiring the curve reproduce certain degeneration in the brane configuration: Where one to allow the D4s either side of the $O6^+$ to line up with their mirror partner and recombine. The unpaired NS5 could then decouple leaving an Sp type configuration. The positions of the D4s are made to match by setting $p(v) = q(v) = p(v^2)$. The curve will factorise appropriately if $B = 0$

$$(y + \Lambda^{N+2}v^{-2}) (y^2 + y(p(v^2) + (A - 1)v^{-2}) + v^{-4}) = 0 \quad (3.84)$$

The second factor is the Sp curve 3.48 when $A = -1$, up to a rescaling of y .

3.2.12 Elliptic Models

As an $O6$ is pointlike in x^6 , the compactified direction, two $O6$ s will appear, one at either end of the spacetime. The charges of these $O6$ s can actually be chosen independently from one another thus providing three different backgrounds $O6^+-O6^-$, $O6^+-O6^+$, $O6^- -O6^-$. Here only the ‘balanced’ scenario $O6^+-O6^-$ will be examined.

A theory with gauge group of the form $Sp \times \prod SU \times SO$ is constructed by placing $n + 1$ NS5s between the two $O6$ s. If one specifies that $\beta = 0$ in all factors then the content is fixed to be

$$G = Sp(2k) \times \prod_{l=1}^n SU(2k + 2l) \times SO(2k + 2n + 2) \quad (3.85)$$

with bifundamental matter. Again the ‘unfrozen’ $U(1)$ is projected out by the orientifold.

If one places an additional NS5 on top of the $O6^-$ the gauge group will change to

$$G = SU(2k) \times \prod_{l=1}^n SU(2k + 2l) \times SO(2k + 2n + 2) \quad (3.86)$$

with the usual bifundamental matter plus an extra hyper in the symmetric two index representation of $SU(2k)$, the first factor. When one restricts to $n = 0$, the single NS5 intersects the $O6^-$ and the resulting theory is $SO(2k + 2)$ with a massless hyper in the symmetric, which is the adjoint. This is the brane construction of the $\mathcal{N} = 4$ $SO(N)$ with N even or odd.

Alternatively, placing the additional brane so it intersects the $O6^+$ results in

$$G = Sp(2k) \times \prod_{l=1}^n SU(2k + 2l) \times SU(2k + 2n + 2) \quad (3.87)$$

with again the usual bifundamental hypers and an extra hyper in the antisymmetric of the last group factor $SU(2k + 2n + 2)$. An $\mathcal{N} = 4$ theory can also be constructed

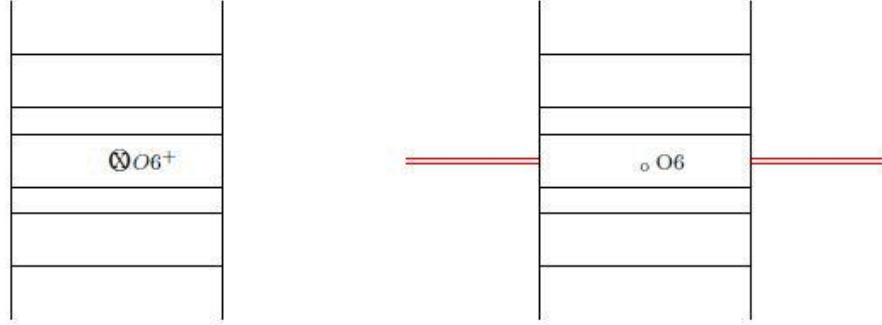

Figure 3-10: Two configurations, one including an $O6^+$, which are equivalent via a Hanany-Witten transition. The figure on the right has a trivial spacetime as there is no longer any D6 charge present.(this figure is taken from [26]).

here by letting $n = 0$. The theory is $Sp(2k)$ with a hyper in the antisymmetric two index representation. As the adjoint of $Sp(2k)$ is antisymmetric this theory has $\mathcal{N} = 4$ supersymmetry.

Finally, combining these last two scenarios so that an NS5 lies on each $O6$ gives a gauge group with SU groups at both ends coupled to symmetric and antisymmetric matter. The minimal model for this case requires two NS5s, one at each $O6$. The resulting theory is not $\mathcal{N} = 4$ but rather $SU(N)$ coupled to both symmetric and antisymmetric hypers.

The derivation of M theory curves for elliptic models encountered previously relied on the interpretation of it as a many-fold cover of E_7 . In the present scenario it is not apparent that such an interpretation exists. In fact one does but it requires generalising the Hanany-Witten transition to deal with $O6$ s

The Hanany-Witten transition for $O6$ planes follows the same principles as for $D6$ s, moving D6 charge across a NS5 causes a D4 to be dragged behind it. For an $O6^+$ there is a +4 D6 charge at the origin, pushing this off to ∞ creates non dynamical D4s when it crosses NS5s. The remnant has no charge and is simply the fixed plane of the spacetime orbifold, see figure 3.2.12.

To see how this manifests in the SW curve consider the pure $SO(2k)$ curve

$$y^2 + B(v^2)y + v^4 = 0 \quad yz = v^4 \quad (3.88)$$

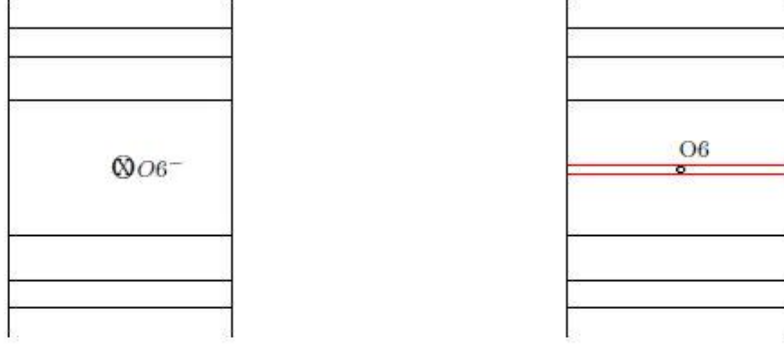

Figure 3-11: Two configurations, one including an $O6^-$, which are equivalent via a Hanany-Witten transition. The figure on the right has had the spacetime trivialised by bringing in D6s from infinity cancelling any D6 charge present. (this figure is taken from [26]).

As with the transition for D6s the configuration on the right of ?? is related to the one left by a change of coordinates which trivialises the spacetime. Changing to $y = y'v^2$, $z = z'v^2$ results in

$$v^2 y'^2 + B(v^2) y' + v^2 = 0 \quad y' z' = 1 \quad (3.89)$$

For an $O6^-$, D6s are brought in from infinity to cancel the negative D6 charge at the origin (see figure 3.2.12). A similar change of coordinates can reproduce this in the SW curve. For example consider the pure $Sp(2k)$ theory

$$y^2(B(v^2) - 2v^{-2})y + v^{-4} = 0 \quad yz = v^{-4} \quad (3.90)$$

Letting $y' = yv^2$, $z' = zv^2$ results in

$$y'^2 + (v^2 B(v^2) - 2)y' + 1 = 0 \quad y' z' = 1 \quad (3.91)$$

Using this one is able to construct the M theory curves for elliptic models with $O6$ s. As an example consider the $O6^+ - O6^-$ configuration with no NS5s intersecting the orientifolds. The gauge group is $Sp(2k) \times \cdots \times SO(2k + 2l + 2)$. During the HW transition, the number of new non dynamical D4s between pairs increases by 2 with every pair further away from the $O6^+$ (see figure 3.2.12). After this it is then possible

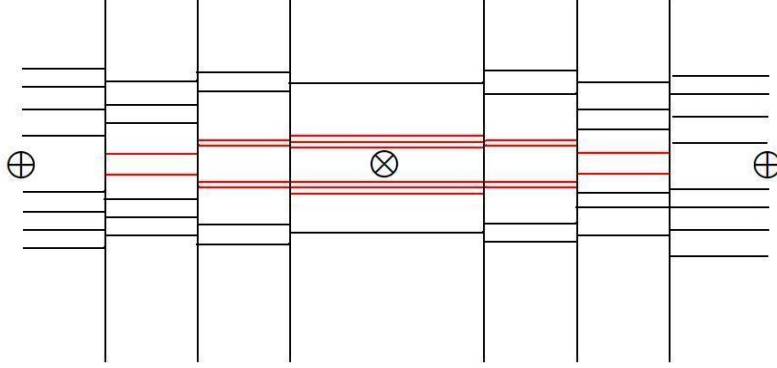

Figure 3-12: An $O6^+ - O6^-$ configuration with $k = 1, l = 2$. The \oplus are the remnants of $O6^+$ s and the \otimes an $O6^-$ remnant. The red horizontal lines indicate the non dynamical D4s created.

to interpret the M theory curve as the $2k + 2l + 2$ -fold cover of E_τ

$$\Sigma : v^{2k+2l+2} + f_1(x, y)v^{2k+2l+1} + \dots + f_{2k+2l+2}(x, y) = 0 \quad (3.92)$$

$$E_\tau : y^2 = (x - e_1(\tau))(x - e_2(\tau))(x - e_3(\tau)) \quad (3.93)$$

4. $\mathcal{N} = 2$ Dualities

In this section the work of [28] is reviewed. The aim of this work is to extend the strong coupling dualities found in [27] to $SU(N)$ gauge groups and products thereof. In the process, a different M theory description of certain superconformal theories to that which was espoused in chapter 5 will be presented. The discovery of these new dualities relies on a realisation of the SW curve as a multi sheeted covering over a punctured Riemann surface.

For example, the theory $SU(N)^n$ with bifundamental matter and fundamentals coupled to the first and last groups has vanishing β function in all factors. The new M theory description of this will be the w.v. theory of N coincident M5 branes wrapping a Riemann sphere with $n + 3$ punctures two of which are distinguished. In general, any 6d $(2, 0)$ A_{n-1} theory, compactified on a punctured Riemann surface (in such a way as to preserve 8 supercharges) will result in a 4d $\mathcal{N} = 2$ SCFT whose SW curve is an N sheeted covering of the Riemann surface and space of UV couplings is the moduli space of such surfaces.

It is possible to classify all theories of this kind by exploring the possible degenerations of the surface [29]. The punctures of the surface are associated, in a precise way, to certain subgroups of the flavor symmetry. Different types of punctures to different subgroups. By considering collisions and permutations of punctures, all different dual weak and strong coupling limits of the theory are obtained. The maximal degeneration of a surface is a collection of three punctured spheres. One can consider these as building blocks and by glueing them together all possible theories described above can be constructed. To begin with we deal with $SU(2)$ then $SU(3)$ and lastly $SU(N)$

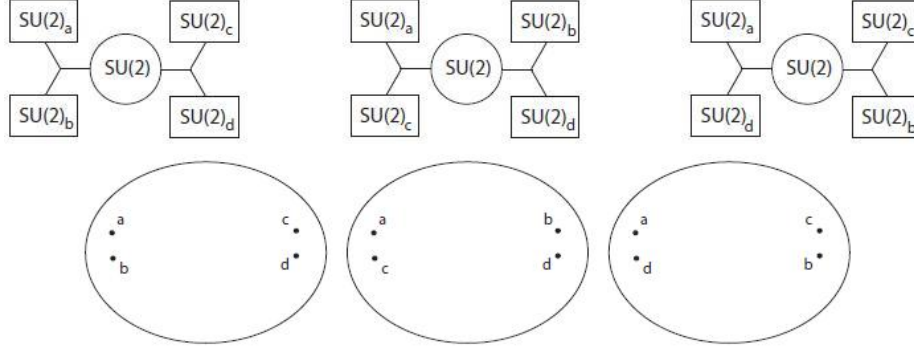

Figure 4-1: The various weak coupling cusps of $SU(2), N_f = 4$. At the top are the depicted the generalised quivers of the theory. A box is a subgroup of flavor while a circle is a weakly coupled gauge group. Below these are the corresponding arrangements of punctures to which that cusp is related. (this figure is taken from [28]).

4.1 AS and G Dualities

4.1.1 $SU(2)$

$SU(2)$ coupled to 4 fundamental hypers has vanishing β function, the hypers transform as 8 half hypers in the vector of $SO(8)$. The S-duality group is $SL(2, \mathbb{Z})$ which combines with the triality of $SO(8)$ to permute the representation of the 4 hypers among the 8d representations of $SO(8)$. If one considers the 4 hypers as two groups of two, $SO(8) \rightarrow SO(4) \times SO(4) = SU(2)_a \times SU(2)_b \times SU(2)_c \times SU(2)_d$, each hyper has its own $SU(2)$ of flavor. The basic representations decompose as

$$\underline{\mathfrak{8}}_v \rightarrow \underline{2}_a \times \underline{2}_b \oplus \underline{2}_c \times \underline{2}_d \quad (4.1)$$

$$\underline{\mathfrak{8}}_s \rightarrow \underline{2}_b \times \underline{2}_c \oplus \underline{2}_a \times \underline{2}_d \quad (4.2)$$

$$\underline{\mathfrak{8}}_c \rightarrow \underline{2}_a \times \underline{2}_c \oplus \underline{2}_b \times \underline{2}_d \quad (4.3)$$

so in this subgroup of the flavor the effect of triality is to permute $SU(2)_a, SU(2)_b, SU(2)_c, SU(2)_d$. The hypers can be given masses, m_a, m_b, m_c, m_d and these will be permuted along with the $SU(2)$ s by S-duality.

The gauge coupling space for this theory is $\mathcal{M}_{4,0}$, the moduli space of a Riemann

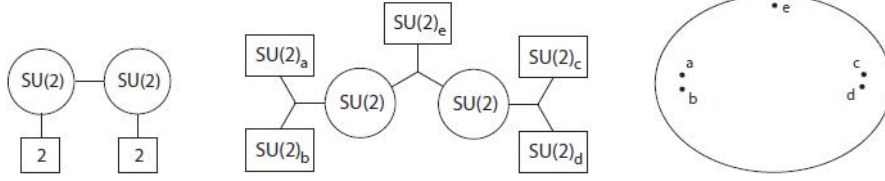

Figure 4-2: On the left is the regular quiver of the $SU(2)^2$ theory. In the middle the generalised quiver making explicit the $SU(2)^5$ subgroup of flavor symmetry. On the right is the associated punctured Riemann surface. (this figure is taken from [28]).

sphere with 4 indistinguishable punctures ¹. $SL(2, \mathbb{Z})$ permutes the punctures so to each one we associate an $SU(2)$ subgroup of flavor and a mass. Collisions of the punctures corresponds to weak coupling limits of the theory, for example a and b colliding result in $\tau \rightarrow i\infty$.

Is it possible to have the same relation between punctures and flavor subgroups for gauge groups that are products of $SU(2)$? Start with $SU(2)_1 \times SU(2)_2$ with one bifundamental and two fundamentals coupled to each group figure 4.1.1. This theory has two marginal gauge couplings τ_1, τ_2 and has the following subgroup of the full flavor, $SU(2)_a \times SU(2)_b \times SU(2)_c \times SU(2)_d \times SU(2)_e$. Four of these $SU(2)$ s come from the fundamentals and the other from the bifundamental (the bifundamental is a real representation so the flavor symmetry is enhanced from $U(1)$ to $Sp(2) \cong SU(2)$).

If $SU(2)_2$ is sent to weak coupling then the gauge group reduces to $SU(2)_1$ with subgroup of flavor $SU(2)_a \times SU(2)_b \times SU(2)_e \times SU(2)_2$. S-duality of a single $SU(2)$ gauge theory will permute each of the $SU(2)_a, SU(2)_b, SU(2)_e, SU(2)_2$ among themselves. By turning the coupling of $SU(2)_2$ back on and sending $\tau_1 \rightarrow i\infty$ the other $SU(2)$ s can be permuted thus all five flavor $SU(2)$ s are permuted by S-duality. The full flavor group is not $SL(2, \mathbb{Z}) \times SL(2, \mathbb{Z})$ as the $SL(2, \mathbb{Z})$ s of each gauge group factor do not commute.

¹ In chapter Chapter 5 the coupling space of all SU theories was found to be $\mathcal{M}_{(n+1,2),0}$ but for $SU(2)$ there is an enhancement to $\mathcal{M}_{4,0}$. This can be understood by noting that $SU(2) = Sp(2)$. The coupling space of Sp theories is different and their combination gives $\mathcal{M}_{4,0}$

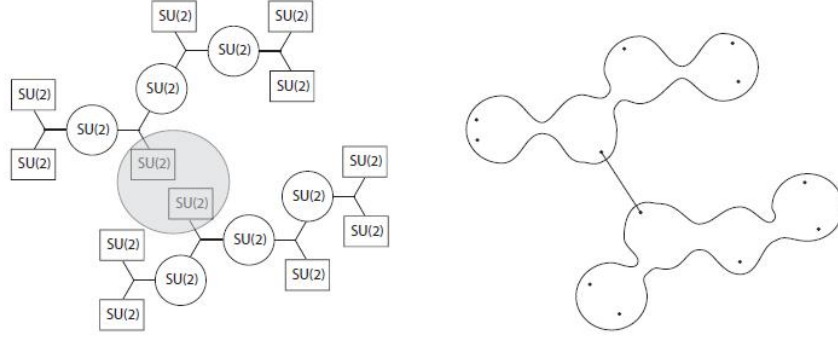

Figure 4-3: On the left is a generalised quiver where a gauge group has been completely decoupled leaving behind the two flavor subgroups highlighted. On the right the corresponding Riemann surface, it has degenerated to two surfaces. The connection between them represents the group that was decoupled (this figure is taken from [28]).

By comparison with the previous case one might suspect that the full S-duality group is $\pi_1(\mathcal{M}_{5,0})$ with $\mathcal{M}_{5,0}$ the space of UV gauge couplings and collisions of punctures corresponding to weak and strong coupling limits. The S-duality group acts on the punctures by permutation. This could be further extended to $SU(2)^n$ gauge group. There is an $SU(2)^{n+3}$ subgroup of the flavor symmetry, one for each of the $n-1$ bifundamentals and 1 one for each the the 4 fundamentals. The corresponding coupling space would be $\mathcal{M}_{n+3,0}$ with duality group $\pi_1(\mathcal{M}_{n+3,0})$ permuting the punctures. The collision of punctures again corresponds to the various coupling limits. As all the punctures are permuted by S-duality the only limits are the weak coupling $\tau_\alpha \rightarrow i\infty$, see figure 4.1.1. Completely decoupling a gauge group factor in this manner causes the Riemann surface to degenerate to two Riemann surfaces and the coupling space $\mathcal{M}_{n+3,0} \rightarrow \mathcal{M}_{m+3,0}\mathcal{M}_{n-m+2,0}$.

For example $SU(2)_1 \times SU(2)_2 \times SU(2)_3$ would have coupling space is $\mathcal{M}_{6,0}$ taking the middle group factor $\tau_2 \rightarrow i\infty$ means the theory is now two uncoupled $SU(2)$, $N_f = 4$ gauge theories each with a subgroup of flavor coming from $SU(2)_2$. The mass parameter of this $SU(2)_2$, m_2^2 comes from the Coulomb branch parameter $u_2 = \text{Tr}\Phi_2^2$. At this limit one is at a point in $\mathcal{M}_{6,0}$ where the six punctured sphere degenerates to two four punctured spheres, see figure 4.1.1. From the point of view of either one

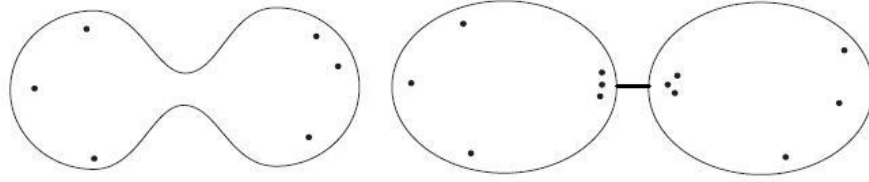

Figure 4-4: At the cusp τ_2 $\mathcal{C}_{6,0}$ degenerates to two 4 punctured spheres. The extra punctures on each part appear to be the result of the collision of three punctures (this figure is taken from [28]).

of the resultant four punctured spheres, three punctures have collided and formed a new puncture. This new puncture is associated to the newly created $SU(2)_2$ of flavor and its mass, m_2 .

The next extension one could consider is quivers that contain g loops. The coupling space is then $\mathcal{M}_{n,g}$ the moduli space of an n punctured genus g Riemann surface. Such theories will be denoted $\mathcal{T}_{n,g}[A_1]$. Thus far no concrete evidence has been given for this proposed relation between punctures and flavor symmetry. To do so we analyse the SW curves of the above theories and see that the described behaviour is reproduced.

4.1.2 SW Curves

First the case of a single $SU(2)$ gauge group will be examined to see how the relationship manifests itself in the SW curve. This analysis will then be extended to product gauge groups and give the desired ‘proof’. The SW curve for massless $SU(2)$, $N_f = 4$ constructed using the methods of chapter 5 is

$$v^2 t^2 + c_1(v^2 - u)t + c_2 v^2 = 0, \quad \lambda = v \frac{dv}{t} \quad (4.4)$$

which can be rearranged to give

$$(t - t_1)(t - t_2)v^2 = ut, \quad \lambda = \frac{\sqrt{u}}{\sqrt{t(t - t_1)(t - 1)}}dv \quad (4.5)$$

t_2 can be set to 1 as only the ratios of c_1 and c_2 matter. The gauge coupling τ is the complex parameter of the torus

$$y^2 = t(t - 1)(t - t_1) \quad (4.6)$$

The torus degenerates as $t_1 \rightarrow 1, 0, \infty$ which correspond to the limits $\tau \rightarrow i\infty, 0, 1$. These three cusps are equivalent due to the nature of the torus or correspondingly due to the S-duality of the gauge theory. There is, therefore, only one actual cusp $\tau \rightarrow i\infty$.

By changing coordinates to the following, the $SL(2, \mathbb{Z})$ duality can be made more manifest. $v = tx$, $t \rightarrow \left(\frac{az+b}{cz+d}\right)$, $x \rightarrow (cz + d)^2x$ so $dt \rightarrow \frac{dz}{(cz+d)^2}$ brings the SW curve and differential to

$$x^2 = \frac{u}{\Delta_4(z)}, \quad \lambda = xdz \quad (4.7)$$

where $\Delta_4(z)$ is a degree 4 polynomial in z , which is a coordinate on $\mathcal{C}_{4,0}$ a four punctured sphere. The roots of $\Delta_4(z)$ give the locations of the punctures. x is the fibre coordinate of the cotangent bundle of $\mathcal{C}_{4,0}$. This new form of the SW curve

$$x^2 = \phi_2(z), \quad \lambda = xdz, \quad (x, z) \in \mathbb{T}^*\mathcal{C}_{4,0} \quad (4.8)$$

makes explicit its realisation as a two sheeted cover of a punctured Riemann surface. $\phi_2 dz^2$ is a quadratic differential on $\mathcal{C}_{4,0}$. It has simple poles at the punctures and develops a double pole when two punctures collide i.e. at the weak coupling cusps. Thus the SW curve is at once an elliptic curve whose degeneration corresponds to the gauge theory becoming weakly coupled and a 2 sheeted covering of a four punctured sphere where the theory is weakly coupled when the punctures collide. In the first realisation, by reinstating t_2 , only the coupling space $\mathcal{M}_{(4,2),0}$ is apparent whereas in

the second the full $\mathcal{M}_{4,0}$ is exhibited.

We now look to extend this to product gauge groups. The SW curve for such a theory is

$$v^2 t^{n+1} + c_1(v^2 - u_1)t + \cdots + c_{n+1}v^2 = 0 \quad (4.9)$$

or

$$\prod_{\alpha=0}^n (t - t_\alpha)v^2 = U_{n-1}(t)t \quad (4.10)$$

The subscript of a polynomial denotes its degree in the argument shown. The coefficients of $U_{n-1}(t)$ are proportional to the Coulomb branch parameters u_i . Performing the change of coordinates listed above 4.7 gives

$$x^2 = \frac{U_{n-1}(z)}{\Delta_{n+3}(z)} = \phi_2(z), \quad \lambda = xdz \quad (4.11)$$

$(x, z) \in \mathbb{T}^* \mathcal{C}_{n+3,0}$. The quadratic differential $\phi_2 dz^2$ has simple poles at the punctures of $\mathcal{C}_{n+3,0}$. The location of the simple poles parametrises the coupling space (c.f 3.30) which is therefore $\mathcal{M}_{n+3,0}$. The different coupling limits occur when the simple poles coincide. To see the effect of S-duality on the coupling space masses are introduced. The mass deformed 4.9 is

$$(v - m_1)(v - m_2)t^{n+1} + c_1(v^2 - m_3v - u_1)t^n + \cdots + c_{n+1}(v - m_{n+3})(v - m_{n+4}) = 0 \quad (4.12)$$

or

$$\prod_{\alpha=0}^n (t - t_\alpha)v^2 = M_{n+1}(t)v + U_{n+1}(t) \quad (4.13)$$

Each coefficient of $M_{n+1}(t)$ as well as the first and last of $U_{n+1}(t)$ are mass parameters. There are $n + 4$ such coefficients but a shift in v eliminates one of these leaving $n + 3$ physical masses. Solving 4.13 for v one sees that at $t = t_\alpha$ one of the roots $v_\pm(t)$ diverges. The differential λ thus has a pole on one branch at $t = t_\alpha$, it also has poles on both branches at $t = 0, \infty$. The residues of the poles at $t = t_\alpha$ are the masses of the α^{th} bifundamental, while the differences of the residues on both branches at $t = 0, \infty$ are the masses for the 2 sets of fundamentals at both ends. The structure

of the residues in this form only makes an $U(1)$ subgroup of flavor manifest for the bifundamentals. To be able to make a connection between the punctures and $SU(2)$ s of flavor, λ must be modified so its has poles on both branches. To do this one shifts $v \rightarrow v + M/2 \prod(t - t_\alpha)$ so as to remove the term linear in v

$$\prod_{\alpha=0}^n (t - t_\alpha)^2 v^2 = U_{n+1}(t) \prod_{\alpha=0}^n (t - t_\alpha) - \frac{1}{4} M_{n+1}(t)^2, \quad \lambda = \frac{v dt}{t} - \frac{M_{n+1} dt}{t \prod(t - t_\alpha)} \quad (4.14)$$

λ now has poles on both v branches whose residues sum to zero. These are the properties of an element of the Cartan of $SU(2)$. Thus to each puncture we associate an $SU(2)$ subgroup of flavor.

The shift of v caused the differential λ to be brought to an undesirable form it can be returned to $\lambda = v dv/t$ by adding $M dt/t \prod(t - t_\alpha)$. This addition also has residues that are the mass parameters and it does not affect the condition that the derivatives of λ providing a basis of holomorphic differentials on the SW curve (2.75) it is therefore harmless.

To complete the picture perform the change of coordinates ala 4.11

$$x^2 = \frac{P_{2n+2}(z)}{\Delta_{n+3}(z)^2} = \phi_2(z), \quad \lambda = x dz, \quad (x, z) \in \mathbb{T}^* \mathcal{C}_{n+3,0} \quad (4.15)$$

$\phi_2 dz^2$ is a quadratic differential on $\mathcal{C}_{n+3,0}$. For the mass deformed theory it has double poles at the punctures whose residues are the mass parameters, m_α^2 of the theory.

4.1.3 Degeneration limits

To describe the collision of any m punctures one can use S-duality to enter a frame where it is t_0, t_1, \dots, t_{m-2} coalescing with the puncture at $t = 0$. By 3.17 this corresponds to $\tau_{m-1} \rightarrow i\infty$ i.e. the $m - 1^{th}$ node becoming weakly coupled. When this happens the quiver will become two disconnected pieces and the position in $\mathcal{M}_{n+3,0}$ corresponds to the degeneration of the $n + 3$ punctured sphere to an $n - m + 4$ punctured sphere and an $m + 1$ punctured sphere. To reproduce this behaviour in the SW curve one focuses on each of the resultant spheres individually.

Starting with the $n - m + 4$ punctured sphere. Letting $t_\alpha \rightarrow \epsilon t_\alpha, \alpha = 0, 1, \dots, m - 2$, and then $\epsilon \rightarrow 0$ will scale the punctures at t_0, t_1, \dots, t_{m-2} uniformly to 0. In doing so a factor of $\epsilon^{-2(m-1)}$ appears in the residues of the poles at those punctures, coming from Δ_{n+3} . To keep the residues, and hence the masses, finite P_{2n+2} must scale as $\epsilon^{2(m-1)}$ at the punctures t_α . Therefore $P_{2n+2}(t) \rightarrow t^{2(m-1)} P_{2n-2m+4}(t)$ while $\Delta_{n+3} \rightarrow t^m \Delta_{n-m+3}(t)$ (there are m punctures in total colliding at $t = 0$ hence the exponent of t). This leaves a double pole at $t = 0$, whose residue is u_{m-1} the Coulomb branch parameter of the $m - 1^{\text{th}}$ gauge group. The SW curve is

$$x^2 = \frac{P_{2(n-m+2)}(z)}{\Delta_{n-m+4}(z)} \quad (4.16)$$

which is the curve for an $n - m + 1$ node quiver with coupling space $\mathcal{M}_{n-m+4,0}$.

From the point of view of the second sphere the other $n - m + 3$ punctures collide at infinity. To reproduce this $t_\alpha, \alpha = m - 1, \dots, n$ are scaled uniformly to infinity by ϵ^{-1} . Keeping the masses finite requires $\Delta_{n+3}(t) \rightarrow t^{n-m+2} \Delta_{m+1}(t)$ resulting in a double pole at infinity whose residue is u_{m-1} . Performing the usual transformations gives

$$x^2 = \frac{P_{2(m-1)}(z)}{\Delta_{m+1}(z)} \quad (4.17)$$

the SW curve for an $m - 2$ node quiver with coupling space $\mathcal{M}_{m+1,0}$.

Thus at a cusp of the theory $\mathcal{T}_{n+3,0}[A_1] \rightarrow \mathcal{T}_{n-m+4,0}[A_1] \times \mathcal{T}_{m+1,0}[A_1]$ for $m > 2$. By continually decoupling the last node of the quiver i.e. colliding $m = 2$ punctures one sees that the maximal degeneration corresponds to a collection of three punctured spheres, $\mathcal{T}_{n+3,0}[A_1] \rightarrow \mathcal{T}_{3,0}[A_1]^n$. Each $\mathcal{T}_{3,0}[A_1]$ has SW curve

$$x^2 = \frac{P_2(z)}{\Delta_3(z)} \quad (4.18)$$

and when considered by itself is a non interacting theory of 4 hypers transforming as half hypers with $SU(2)^3$ flavor symmetry. Note that each of the coefficients of $P_2(z)$ are mass parameters, there are no Coulomb branch parameters which is correct for a non interacting theory.

This collection is arranged as a graph with the three punctured spheres at the nodes. A line between a pair of nodes associates a puncture on each sphere, the connection itself represents the weakly coupled gauge group and the pair of punctures the flavor symmetry if left behind.

4.1.4 $\mathcal{T}_{n,g}[A_1]$ Theories

The elliptic models of the previous chapter are a special case of an $\mathcal{T}_{n,g}[A_1]$, $g = 1$ theory. They will be used as a starting point with which to suggest a form for the SW curve of the general case. For $SU(2)$ 3.39 reduces to

$$v^2 = f_1(z)v + f_2(z), \quad (v, z) \in \mathbb{C} \times \mathcal{C}_{n,1} \quad (4.19)$$

if there are no masses $f_1(z) = 0$. The term linear in v can be eliminated via the shift $v \rightarrow x + 1/2f_1(z)$

$$x^2 = f_2(z) - \frac{1}{4}f_1(z)^2 = \phi_2(z) \quad (4.20)$$

where $(x, z) \in \mathbb{T}^*\mathcal{C}_{n,1}$. The quadratic differential $\phi_2(z)dz^2$ has double poles at the punctures $z = z_\alpha$ (the n NS5 positions) whose residues are the square of the mass parameters of the α^{th} bifundamental. The coupling space is thus $\mathcal{M}_{n,1}$. The surface $\mathcal{C}_{n,1}$ has two possible types of degeneration. The first is as before, colliding m punctures sees $\mathcal{C}_{n,1}$ degenerate into $\mathcal{C}_{n-m+1,1}$ and $\mathcal{C}_{m+1,0}$. While the second corresponds a pinching of a handle of $\mathcal{C}_{n,1}$ resulting in a genus zero surface with two extra punctures occurring where the surface was pinched. In the process the separation of a pair of punctures either side of the pinch will diverge. Thus a single gauge group in the loop becomes weakly coupled. $\phi_2 dz^2$ acquires double poles at the new punctures with residue being the u parameter of the decoupled group.

Therefore $\mathcal{T}_{n,1}[A_1] \rightarrow \mathcal{T}_{n+2,0}[A_1]$ or $\mathcal{T}_{n-m+1,1}[A_1] \times \mathcal{T}_{m+1,0}[A_1]$. Again the maximal degeneration is a collection of three punctured spheres $\mathcal{T}_{n,1}[A_1] \rightarrow \mathcal{T}_{3,0}[A_1]^{n-1}$.

The generalisation of this to $\mathcal{T}_{n,g}[A_1]$ is immediate. The SW curve is

$$x^2 = \phi_2(z), \quad (x, z) \in \mathbb{T}^*\mathcal{C}_{n,g} \quad (4.21)$$

$\phi_2 dz^2$ is a quadratic differential on $\mathcal{C}_{n,g}$ with simple poles at the punctures and double poles for non zero masses, the residues being m^2 . The coupling space is parametrised by the positions of these poles and so is $\mathcal{M}_{n,g}$ with duality group $\pi_1(\mathcal{M}_{n,g})$.

4.1.5 SU(3)

Some new features are encountered when dealing with $SU(3)$ gauge groups. All cusps of these theories are no longer weakly coupled. Strong coupling cusps are present as the S-duality group is not as large it was for $SU(2)$ (see figure 4.1.5). For example $SU(3)$ coupled to 6 hypers has flavor symmetry $U(6)$ and duality group $\tilde{\Gamma}_0(2)$. This duality group leaves two cusps, the usual weak coupling $\tau \rightarrow i\infty$ and a strong coupling $\tau \rightarrow 1$. At this strong coupling point the theory is actually also weakly coupled via a different form of duality known as Argyres-Seiberg (AS) duality. The dual weakly coupled theory which emerges via AS duality is not the original $SU(3)$ theory at weak coupling but rather an $SU(2)$ gauge theory coupled to one hyper. The $SU(2)$ is a gauged subgroup of the E_6 flavor symmetry of an interacting rank 1 SCFT.

Evidence for this duality is found in the degeneration of one SW curve to the other. One can immediately see that it passes some basic consistency checks. The ranks must agree on both side of the duality. $SU(2)$ is rank one as is the E_6 theory so the total rank is two the same as $SU(3)$. The flavor symmetries also match. The AS dual theory has $SU(6)$ flavor, the commutant of $SU(2)$ in E_6 plus an $SO(2) \cong U(1)$ from the single hyper giving $U(6)$ which is the flavor symmetry of $SU(3)$, $N_f = 6$. A further requirement is that there are the same number of exactly marginal couplings. $SU(3)$ has one as does the dual theory coming from the gauging of the $SU(2)$ (That it is exactly marginal can be confirmed by computing the the central charge of the flavor current algebra for the E_6 theory, [27]).

As in the previous sections we concentrate on certain subgroups of the full flavor symmetry. Splitting the 6 hypers of the single group theory into two sets makes explicit an $SU(3)^2 \times U(1)^2$ subgroup of the flavor. In the AS dual theory the focus will be on $SU(3) \times SU(3) \times U(1)$ where $SU(3) \times SU(3) \subset SU(6)$ and the $U(1)$ is the flavor of the single hyper. Already this signals a departure from the $SU(2)$ theories,

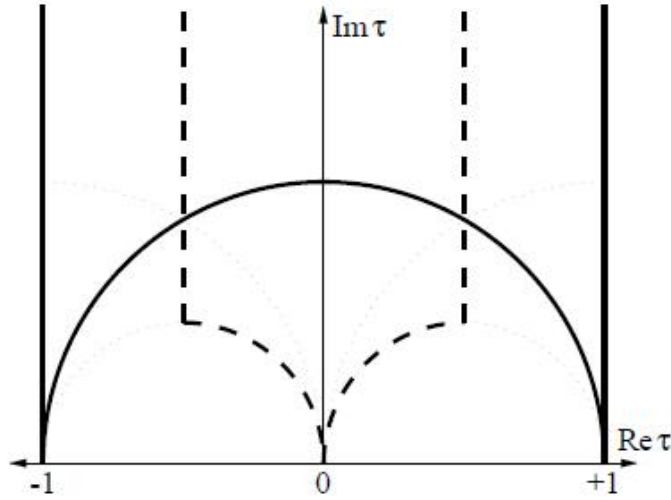

Figure 4-5: The fundamental domains of $\tilde{\Gamma}_0(2)$ (solid lines) and $\Gamma_0(2)$ (dashed line), there is an identification across the $\text{Im}\tau$ axis. $\tilde{\Gamma}_0(2)$ is the duality group for SU and SO groups, $\Gamma_0(2)$ is the duality group for Sp . Strong coupling cusps are present $\tau \rightarrow 1$ for SU and $\tau \rightarrow 1$ for Sp . The intersection of the two domains is the fundamental domain of $SL(2, \mathbb{Z})$ (this figure is taken from [14]).

there are now two types of flavor subgroups.

Consider a linear quiver of $SU(3)$ gauge groups and send a middle node to strong coupling while keeping the rest at weak coupling. At the strongly coupled node there is an $SU(3) \times SU(3)$ flavor group which is weakly gauged at the neighbouring nodes as well as a $U(1)^2$ coming from the 2 bifundamentals. As $\tau \rightarrow 1$ the AS dual theory emerges. The weakly gauged $SU(3) \times SU(3)$ is a subset of $SU(6)$ the commutant of $SU(2)$ in E_6 while the two $U(1)$ s combine to give the $SO(2)$ flavor of the single hyper with a $U(1)$ left over which is the commutant of $SU(3) \times SU(3) \subset SU(6)$.

Were this $SU(2)$ to be ungauged the symmetry of the interacting SCFT will grow to E_6 and decouple from the rest of the theory. The flavor symmetry at the adjacent nodes will grow from the $U(1)$ of the bifundamentals to $SU(3)$ which is the commutant of the $SU(3) \times SU(3) \subset E_6$.

As there are two different types of flavor subgroups there will be two types of associated punctures. Correspondingly the gauge coupling space will be $\mathcal{M}_{(f_1, f_3), g}$,

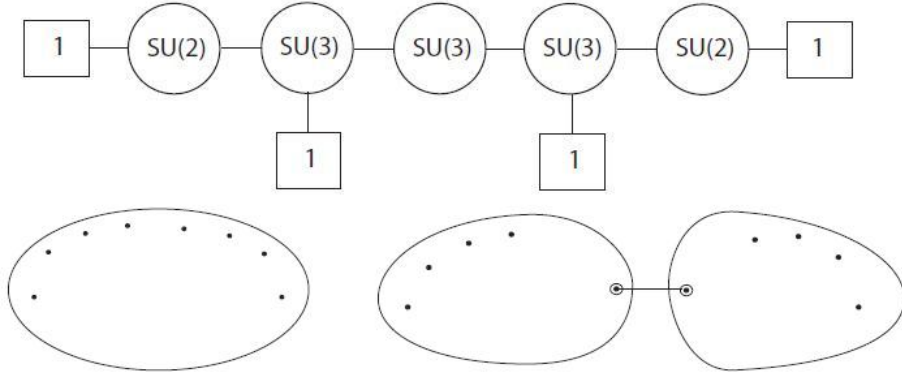

Figure 4-6: An example of a quiver corresponding to a theory with $U(1)^{n+3}$ flavor. Below is the corresponding Riemann surface and its subsequent degeneration when the middle $SU(3)$ is decoupled. (this figure is taken from [28]).

the moduli space of a genus g surface with f_1 basic punctures, associated to $U(1)$ s, and f_3 ‘maximal’ punctures associated to $SU(3)$ s. All degenerations of $\mathcal{C}_{(f_1, f_3), g}$ are related to different generalised quivers which are the various S-dual weak coupling frames of a single $\mathcal{N} = 2$ SCFT theory denoted $\mathcal{T}_{(f_1, f_3), 1}[A_2]$. It has a subgroup of flavor $U(1)^{f_1} \times SU(3)^{f_3}$.

The collision of punctures in the previous case of $SU(2)$ gauge groups always resulted in the total number of punctures being increased by two and the associated cusp being $\tau_{m-1} \rightarrow i\infty$. This will also be true in the present case but the type of puncture produced and the cusp associated to such a collision must be determined and will depend on the situation. A theory with no maximal punctures or loops and $f_1 = n + 3$ has $G = SU(2) \times SU(3)^{n-2} \times SU(2)$ coupled to $n - 1$ bifundamentals and additionally single hypers coupled to each $SU(2)$ factor as well as the first and last $SU(3)$ (See figure 4.1.5). Colliding $m > 2$ punctures corresponds to decoupling one of the $SU(3)$ factors. The associated Riemann surface thus degenerates to two punctured spheres each with a maximal puncture corresponding to the $SU(3)$ of flavor left after decoupling the $SU(3)$. If $m = 2, n + 1$ the gauge group being weakly coupled is $SU(2)$. The surface degenerates to a three punctured sphere and a surface with $n + 2$ punctures. From the point of view of the $n + 2$ punctured sphere two basic punctures have coalesced to form a single maximal one. The decoupled $SU(2)$ is a subgroup of an $SU(3)$, the flavor group it leaves behind

grows to $SU(3)$. Thus $\mathcal{T}_{(f_1,0),0}[A_2] \rightarrow \mathcal{T}_{(f_1-m,1),0}[A_2] \times \mathcal{T}_{(m,1),0}[A_2]$ $m \geq 2$

Thus one can transition between the quiver theory figure (??) with $G = SU(2) \times SU(3)^{n-2} \times SU(2)$ to the more standard $G = SU(3)^{n-2}$ by colliding first 2 punctures then n punctures to form two new maximal punctures i.e. decoupling the 2 $SU(2)$ gauge groups. The opposite transition can also be made, starting with $G = SU(3)^{n-2}$, an $SU(2)$ subgroup of the $SU(3)$ flavor at the end nodes can be gauged. Here, the two maximal punctures have been pulled apart to each give two basic punctures, $\mathcal{C}_{(n+1,2),0} \rightarrow \mathcal{C}_{(n+3,0),0}$.

Starting with $\mathcal{T}_{(6,0),0}[A_2]$ which has gauge group $G = SU(2) \times SU(3) \times SU(2)$. Colliding any two of the basic punctures causes one of $SU(2)$ gauge groups. There are three such pairwise collisions and performing them all decouples three $SU(2)$ gauge groups, the third being a hidden $SU(2) \subset SU(3)$. The resulting theory $\mathcal{T}_{(0,3),0}[A_2]$ is the interacting E_6 SCFT. The flavor symmetry left after decoupling a single $SU(2)$ leaves an $SU(3)$ flavor symmetry, decoupling another this symmetry to the commutant of $SU(3)$ in E_6 , decoupling all three enhances the symmetry to the full E_6 .

The maximal degeneration of $\mathcal{T}_{(f_1,f_3),0}[A_2]$ will be a collection of three punctured spheres of three different types; $\mathcal{C}_{(0,3),0}$ corresponding to the E_6 theory, $\mathcal{C}_{(1,2),0}$ being a free theory of nine hypers transforming in the $(3, 3)$ of the $SU(3) \times SU(3)$ flavor symmetry and a sphere with two basic punctures and one irregular puncture (see section on Tinkertoys) which represents a free theory of two hypers in the fundamental of $SU(2)$ flavor.

The theory involving higher genus surfaces, $\mathcal{T}_{(f_1,f_3),g}[A_2]$, will have different degenerations other than those resulting from punctures colliding. These occur when a handle of the surface is pinched off which reduces the genus by one but adds two new maximal punctures, $\mathcal{T}_{(f_1,f_3),g}[A_2] \rightarrow \mathcal{T}_{(f_1,f_3+2),g-1}[A_2]$. By colliding punctures however the genus can be reduced in greater steps, $\mathcal{T}_{(f_1,f_3),g}[A_2] \rightarrow \mathcal{T}_{(f_1-f'_1,f_3-f'_3+1),g-g'}[A_2] \times \mathcal{T}_{(f'_1,f'_3+1),g'}[A_2]$. At cusps of $\mathcal{M}_{(f_1,f_3),g}$ get all possible degenerations of $\mathcal{C}_{(f_1,f_3),g}$ which are related to all possible S-dual coupling limits of $\mathcal{T}_{(f_1,f_3),g}[A_2]$. Generic cusps correspond to all possible maximal degenerations of the Riemann surface into a collection of three punctured spheres. They are arranged into a graph with g loops. The con-

nections between the spheres correspond to the weakly coupled gauge groups which this time can be $SU(2)$ or $SU(3)$.

4.1.6 SW Curves

The proposed behaviour discussed above can be confirmed by analysing SW curves. The curve for $G = \prod SU(3)$ quiver theory with $\beta=0$ in all factors and no masses

$$v^3 t^{n+1} + c_1(v^3 + u_1^{(2)}v + u_1^{(3)})t^n + \dots + c_{n+1}v^3 = 0 \quad (4.22)$$

the $u_i^{(d)}$ are Coulomb branch parameters. Rearranging as before gives

$$\prod_{\alpha=0}^n (t - t_\alpha)v^3 = U_{n-1}^{(2)}(t)tv + U_{n-1}^{(3)}(t)t \quad (4.23)$$

the coefficients of $U_{n-1}^{(2)}(t), U_{n-1}^{(3)}(t)$ are $u_i^{(2)}, u_i^{(3)}$ respectively. For example when $n = 1$

$$(t - 1)(t - t_1)v^3 = u^{(2)}tv + u^{(3)}t \quad (4.24)$$

or with $v = tx$

$$x^3 = \frac{u^{(2)}}{(t - 1)(t - t_1)t}x + \frac{u^{(3)}}{(t - 1)(t - t_1)t^2} \quad (4.25)$$

performing a fractional linear transformation brings this to the new form of the curve for $SU(3)$ product groups

$$x^3 = \phi_2(z)x + \phi_3(z), \quad \lambda = xdz \quad (4.26)$$

(x, z) are coordinates on the cotangent bundle of a punctured sphere. $\phi_2(z)dz^2$ is a quadratic differential and $\phi_3(z)dz^3$ a cubic differential on the punctured sphere. $\phi_2(t)dt^2$ has simple poles at all the punctures while $\phi_3(t)dt^3$ has simple poles at $t = 1, t_1$, call these punctures basic and double poles at $t = 0, \infty$ call these maximal. As always the coupling space is determined by the position of these punctures and so is $\mathcal{M}_{(2,2),0}$.

If $t_1 \rightarrow 1$ the AS dual theory should emerge, the curve goes to

$$x^3 = \frac{u^{(2)}}{(t-1)^2 t} x + \frac{u^{(3)}}{(t-1)^2 t^2} \quad (4.27)$$

$\phi_2(t)dt^2$ now has a double pole at $t = 1$ which indicates a mass deformation of the theory. The residue of this pole, $u^{(2)}$, is the square of the mass parameter associated to the flavor symmetry left behind by ungauging the $SU(2)$. Setting $u^{(2)} = 0$

$$x^3 = \frac{u^{(3)}}{(t-1)^2 t^2} \quad (4.28)$$

which is SW curve for the E_6 SCFT (The Coulomb branch described by 4.28 has $\dim_{\mathbb{C}} = 1$ and is parametrised by a dimension 3 operator, the only rank 1 theory with such a Coulomb branch is the E_6 theory). Here $(x, z) \in T^*\mathcal{C}_{(0,3),0}$ thus confirming the identification of $\mathcal{T}_{(0,3),0}[A_2]$ with the E_6 theory.

From 4.23 one sees that generally $\phi_2(t)dt^2$ has only simple poles as does $\phi_3(z)dz^3$ except at $t = 0, \infty$, the maximal punctures. The others being basic punctures. The coupling space is $\mathcal{M}_{(n+1,2),0}$.

At this point another way of viewing the Coulomb branch, \mathcal{C} becomes apparent. The quadratic and cubic differentials are parametrised respectively by $u_i^{(2)}, u_i^{(3)}$. Thus \mathcal{C} is actually a graded vector bundle V over $\mathcal{M}_{(f_1, f_3), g}$

$$V = V_2 \oplus V_3 \quad (4.29)$$

where V_k is the space of K -differentials with appropriate poles at the punctures $z = z_i$. Or to put it another way, to each Coulomb branch parameter one associates a meromorphic section of the bundle of k -differentials on $\mathcal{C}_{(f_1, f_3), 0}$. The dimension of V_k is

$$d_k = (2k-1)(g-1) + \sum_{i=1}^n p_k^{(i)} \quad (4.30)$$

where $p_k^{(i)}$ is the order of the i^{th} pole of $\phi_k dz^k$.

To begin associating punctures with flavor subgroups we start we the case of

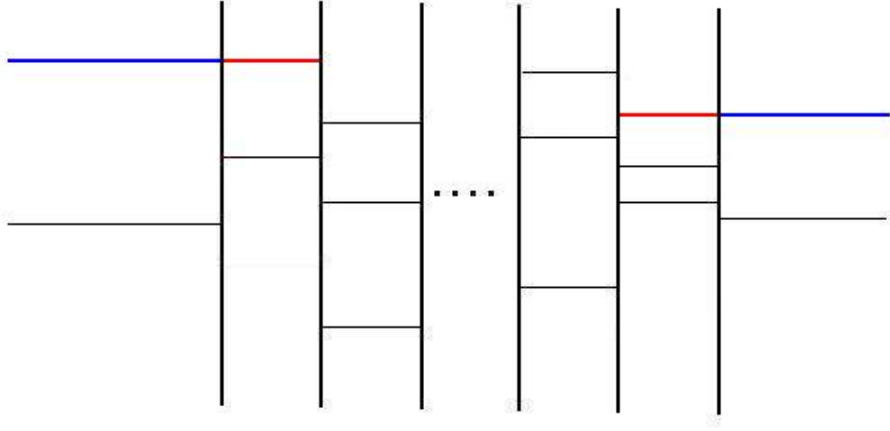

Figure 4-7: The brane configuration of the quiver depicted in 4.1.5. The blue lines represent two coincident semi infinite D4s one of which combines with a D4 (now nondynamical and shown in red) in first or last pair. This has the effect of reducing the first and last gauge groups to $SU(2)$ while coupling a single hyper to these $SU(2)$ s as well as to the first and last $SU(3)$. This can be realised via Hanany-Witten transition from a configuration with $D6$ s. The brane realisation of pulling apart a maximal is seen as the forcing together of D4s.

$U(1)^{n+3}$ flavor symmetry. Such a theory was discussed in the previous section, $\mathcal{T}_{(n+3,0),0}[A_2]$, its curve is

$$v^3 t^{n+1} + c_1 v(v^2 - u_1^{(2)})t^n + c_2(v^3 - u_1^{(2)}v - u_1^{(3)})t^{n-1} + \dots + c_n v(v^2 - u_n^{(2)})t + c_{n+1} v^3 = 0 \quad (4.31)$$

The brane set up used to construct this theory is depicted in figure 4.1.6. It consists of $n + 1$ NS5s with 3 D4s suspended between each pair and 3 semi infinite D4s at each end. Two of the semi infinite D4s at either end are coincident while one of the D4s in the first and last lines up with these coincident pairs. Each coefficient of $u_i^{(2)}$ has a factor t^k , $k \geq 1$ while the coefficients of $u_i^{(3)}$ all have a $k \geq 2$, hence

$$\prod_{\alpha=0}^n (t - t_\alpha) v^3 = U_{n-1}^{(2)}(t)tv + U_{n-1}^{(3)}(t)t^2 \quad (4.32)$$

or

$$x^3 = \frac{U_{n-1}^{(2)}(t)}{\prod_{\alpha=0}^n (t - t_\alpha)t} x + \frac{U_{n-3}^{(3)}(t)}{\prod_{\alpha=0}^n (t - t_\alpha)t} = \frac{U_{n-1}^{(2)}(z)}{\Delta_{n+3}(z)} x + \frac{U_{n-3}^{(3)}(z)}{\Delta_{n+3}(z)} \quad (4.33)$$

All the poles are simple, the gauge coupling space is $\mathcal{M}_{(n+3,0),0}$. As the flavor symmetry here is $U(1)^{n+3}$ each of these punctures, with simple poles, will be related to a $U(1)$, thereby justifying their labelling as basic punctures. To make the relationship more precise masses must be introduced. The massive form of 4.31 is

$$(v - m_1)(v - m_2)^2 t^{n+1} + c_1(v - m_2)(v^2 - m_3 v - u_1^{(2)}) t^n + c_2(v^3 - m_4 v^2 - u_2^{(2)} v - u_1^{(3)}) t^{n-1} + \dots + c_n(v - m_{n+3})(v^2 - m_{n+2} v - u_n^{(2)}) t + c_{n+1}(v - m_{n+3})(v - m_{n+4})^2 = 0$$

or with $v = tx$

$$\prod_{\alpha=0}^n (t - t_\alpha) v^3 = M_{n+1}(t) v^2 + V_{n+1}^{(2)}(t) v + V_{n+1}^{(3)}(t) \quad (4.34)$$

At $t \rightarrow \infty$,

$$v^3 = (2m_2 + m_1) v^2 - (m_2^2 + 2m_1 m_2) v + m_1 m_2^2 + \mathcal{O}(1/t) \quad (4.35)$$

which implies $v_\alpha(t) \sim (m_1 + \mathcal{O}(1/t), m_2 + \mathcal{O}(1/t), m_2 + \mathcal{O}(1/t))$ and similarly as $t \rightarrow 0$ $v_\alpha(t) \sim (m_{n+3} + \mathcal{O}(t), m_{n+4} + \mathcal{O}(t), m_{n+4} + \mathcal{O}(t))$. Thus λ has poles on all three v branches at $t = 0, \infty$. At the other punctures however there is only a pole on one of the branches. To ensure pole on all three branches at every puncture one must shift $v \rightarrow v + M_{n+1}/3 \prod_{\alpha=0}^n (t - t_\alpha)$ to eliminate the term quadratic in v . This also has the effect of forcing the residues on all branches at a punctures to sum to zero. The shifted curve is

$$v^3 = \frac{\frac{1}{3} M_{n+1}^2(t) + V_{n+1}^{(2)}(t) \prod_{\alpha=0}^n (t - t_\alpha)}{\prod_{\alpha=0}^n (t - t_\alpha)^2} + \frac{\frac{2}{27} M_{n+1}^3(t) + \frac{1}{3} M_{n+1}^2(t) V_{n+1}^{(2)}(t) + V_{n+1}^{(3)}(t)}{\prod_{\alpha=0}^n (t - t_\alpha)^3} \quad (4.36)$$

and at all poles the residues are of the form $(2m, -m, -m)$. The constant m is the mass parameter of the associated $U(1)$. The final form of the curve is

$$x^3 = \frac{P_{2n+2}^{(2)}(z)}{\Delta_{n+3}^2(z)} x + \frac{P_{3n+3}^{(3)}(z)}{\Delta_{n+3}^2(z)} \quad (4.37)$$

To identify maximal punctures with $SU(3)$ subgroups of flavor use 4.23. The massive curve is

$$(v - m_1)(v - m_2)(v - m_3)t^{n+1} + c_1(v^3 - m_4v^2 - u_1^{(2)}v - u_1^{(3)})t^n + \dots \\ \dots + c_n(v^3 - m_{n+3}v^2 - u_n^{(2)}v - u_n^{(3)})t + c_{n+1}(v - m_{n+4})(v - m_{n+5})(v - m_{n+6}) = 0$$

as $t \rightarrow \infty$

$$v^3 = (m_3 + m_2 + m_1)v^2 - (m_1m_2 + m_2m_3 + m_1m_3)v + m_1m_2m_3 + \mathcal{O}(1/t) \quad (4.38)$$

hence the residues are unrestricted $v_\alpha(t) \sim (m_1 + \mathcal{O}(1/t), m_2 + \mathcal{O}(1/t), m_3 + \mathcal{O}(1/t))$ while for $t \rightarrow 0$ $v_\alpha(t) \sim (m_{n+4} + \mathcal{O}(t), m_{n+5} + \mathcal{O}(t), m_{n+6} + \mathcal{O}(t))$. As before there are poles only on one of the branches for the punctures $t = t_\alpha$. After a shift of v will ensure poles on all branches at every puncture. After this the residues at the $t = 0, \infty$ are $(m_a + m_b, -m_a, -m_b)$ which are of the form of a Cartan of $SU(3)$. The labelling of these as maximal punctures is thereby justified. The curve for the general theory $\mathcal{T}_{(f_1, f_3), 0}[A_2]$ is

$$x^3 = \frac{P_{2f_1+2f_3-4}^{(2)}(z)}{\Delta_{f_1}^2(z)\Delta_{f_3}^2(z)}x + \frac{P_{3f_1+3f_3-6}^{(3)}(z)}{\Delta_{f_1}^3(z)\Delta_{f_3}^3(z)} \quad (4.39)$$

A consequence of the shift in v is to make basic and maximal no longer distinguishable by the order of the poles, instead they are distinguished by the structure of the residues of λ at the punctures. This is a more natural way to classify the punctures and will be employed when dealing with $SU(N)$.

4.1.7 Degeneration Limits

In $\mathcal{T}_{(n+3, 0), 0}[A_2]$ the decoupling of the $m - 1^{\text{th}}$ gauge group corresponds to scaling t_0, t_1, \dots, t_{m-2} to $t = 0$ c.f. 3.17. For $m = 2$ the decoupled group factor is an $SU(2)$. The massless curve is 4.31, by sending $t_0 \rightarrow 0$ the differentials develop double poles at $t = 0$

$$x^3 = \frac{U_{n-1}^{(2)}(t)}{\prod_{\alpha=1}^n (t - t_\alpha)t^2}x + \frac{U_{n-3}^{(3)}(t)}{\prod_{\alpha=1}^n (t - t_\alpha)t^2} \quad (4.40)$$

The residue of the double pole $\phi_2(t)dt^2$ is $u_{n-1}^{(2)}$, the Coulomb branch parameter of the end $SU(2)$. This is the square of the mass parameter, m_1^2 of the $SU(3)$ of flavor left behind by the decoupling group factor. As $\phi_3(t)dt^3$ only has a double pole rather than a triple the residue is $(m_1, -m_1, 0)$. This is expected, the decoupling $SU(2)$ only has one Coulomb branch parameter to convert into a mass.

The collision of $n - 1 > m > 2$ punctures results in an $SU(3)$ gauge group being decoupled. Scaling $t_\alpha, \alpha = 0, 1, \dots, m - 2$ to 0 uniformly by ϵ introduces extra factors of $\epsilon^{-2(m-1)}$ in the residues at $t = t_\alpha$. Keeping the masses finite requires appropriate scaling of $P_{2n+2}^{(2)} \rightarrow \epsilon^{2(m-1)}P_{2n+2-2(m-1)}^{(2)}$, $P_{3n+3}^{(3)} \rightarrow \epsilon^{3(m-1)}P_{3n+3-3(m-1)}^{(2)}$. The final form of the curve is

$$x^3 = \frac{P_{2(n+3-m)-2}^{(2)}(z)}{\Delta_{n+3-m}^2(z)\Delta_1^2(z)}x + \frac{P_{3(n+3-m)-6}^{(3)}(z)}{\Delta_{n+3-m}^3(z)\Delta_1^3(z)} \quad (4.41)$$

which is the curve for $\mathcal{T}_{(n+3-m,1),0}[A_2]$.

4.1.8 $\mathcal{T}_{(f_1, f_3), g}[A_2]$

Elliptic models with $SU(3)$ gauge groups serve as a starting point for studying theories involving arbitrary loops. From 3.39 the curve is

$$v^3 = f_1(z)v^2 + f_2(z)v + f_3(z), \quad \lambda = vdz \quad (4.42)$$

(x, z) are this time coordinates on the cotangent bundle of a punctured torus. Residues of the simple poles of $f_1(z)$ at the punctures are mass parameters, thus the massless theory has $f_1(z) = 0$. A shift of $v \rightarrow x + f_1/3$ brings 4.42 to

$$x^3 = \left(\frac{1}{3}f_1^2 + f_2\right)x + \left(\frac{2}{27}f_1^3 + \frac{1}{3}f_1f_2 + f_3\right) = \phi_2(z)x + \phi_3(z) \quad (4.43)$$

$\phi_2(z)dz^2$ and $\phi_3(z)dz^3$ are quadratic and cubic differentials on the torus with double and triple poles at the punctures. For zero masses there are only simple poles, an elliptic model without D6s only has bifundamental matter hence basic punctures. A

general quiver with g loops, f_1 $U(1)$ s and f_3 $SU(3)$ s will have SW curve

$$x^3 = \phi_2(z)x + \phi_3(z), \quad (x, z) \in T^*\mathcal{C}_{(f_1, f_3), g} \quad (4.44)$$

where for zero masses $\phi_2(z)x + \phi_3(z)$ has simple poles at the punctures as does $\phi_3(z)dz^3$ except at the maximal punctures where it has double poles. When the masses are all non zero the quadratic and cubic differentials have double and triple poles at all punctures. The residues of the poles of λ are of the form $(2m, -m, -m)$ at the basic punctures and $(m_1 + m_2, -m_1, -m_2)$ at the maximal punctures.

4.1.9 SU(N)

As the rank of the constituent gauge groups are increased the number of puncture types grows also. They will no longer be classified according to the order of the poles they induce in the differentials. Instead they are labelled according to form of the residues of the poles they induce in λ (when the masses are all zero, λ is holomorphic so revert to previous system of classification) To start labelling the different punctures one first needs the SW curve. The natural generalisation of 4.44 to $SU(N)$ is

$$x^N = \sum_{k=2}^N x^{N-k} \phi_k(z), \quad \lambda = xdz \quad (4.45)$$

where $(x, z) \in T^*\mathcal{C}_{(\underline{f}), g}$, \underline{f} indicating the number of punctures of each type. $\phi_k(z)x + \phi_k(z)$ are k -differentials on $\mathcal{C}_{(\underline{f}), g}$ with poles of order at most $k - 1$ for zero masses or k at the punctures.

To each puncture associate a Young diagram with N boxes. Each puncture will have N residues, one on each branch which sum to zero (there is no x^{N-1} term in 4.45). Some of these residues may be the same. If there are h_t identical residues the Young diagram has a column of height h_t , see figure 4-8. The flavor symmetry associated to this puncture as well as the pole structure are encoded in this Young diagram. If N_h is the number of columns of height h then the N_h sets of h identical residues to form a Cartan element of $U(N_h)$, therefore the flavor subgroup of such a

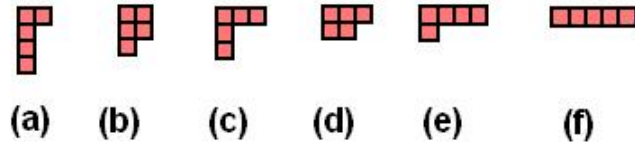

Figure 4-8: The Young diagrams for the $SU(5)$ theory. (a) The basic puncture with pole structure $p_i = \{1, 1, 1, 1\}$ and residues $(4m, -m, -m, -m, -m)$ the associated flavor is $U(1)$. (b) $p_i = \{1, 1, 2, 2\}$, $(m, m, -2/3m, -2/3m, -2/3m)$, $U(1)$. (c) $p_i = \{1, 2, 2, 2\}$, $(m_1, m_2, -1/3(m_1 + m_2), -1/3(m_1 + m_2), -1/3(m_1 + m_2))$, $U(1) \times SU(2)$. (d) $p_i = \{1, 2, 2, 3\}$, $(2(M_1 + m_2), -m_1, -m_1, -m_2, -m_2)$, $U(1) \times SU(2)$ (e) $p_i = \{1, 2, 3, 3\}$, $(-1/2(m_1 + m_2 + m_3), -1/2(m_1 + m_2 + m_3), m_1, m_2, m_3)$, $U(1) \times SU(3)$. (f) The maximal puncture $p_i = \{1, 2, 3, 4\}$, $(m_1 + m_2 + m_3 + m_4, -m_1, -m_2, -m_3, -m_4)$, $SU(5)$

puncture is $S\left(\prod_{h=1}^N U(N_h)\right)$. The pole structure of the massless theory is obtained by numbering the boxes. Starting at the top left with 0 and moving along a row. At the end of a row start on the next with the same number. The order of the poles is given by this list (ignoring the initial zero). A diagram with one column height $N - 1$ and one of height 1 has poles $p_1 = \{1, \dots, 1\}$ corresponds to basic puncture, $U(1)$ flavor. A diagram with only one row of N boxes has $p_i = i - 1$ and is a maximal puncture.

4.1.10 Gaiotto Duality

Now we examine the behaviour of $SU(N)$ theories at various cusps before confirming this by analysing 4.45. For $SU(3)$ the collision of basic punctures produced a maximal puncture, to see if this is true in general consider the theory with only $U(1)$ flavors, i.e. only basic punctures. The gauge group is $\prod_{i=2}^{N-1} SU(i) \times SU(N)^{n-2(N-2)} \times \prod_{i=2}^{N-1} SU(N + 1 - i)$ the end nodes are coupled to single hypers (see figure 4-9).

Colliding $m = 2, n - 1$ punctures corresponds to one of $SU(2)$ going to weak coupling. This leaves behind at least an $SU(2)$ of flavor. The puncture produced by this collision has diagram with three columns one of height $N - 2$ and two of height 1. The flavor associated to this is $U(1) \times SU(2)$ for $N = 3$ this is enhanced

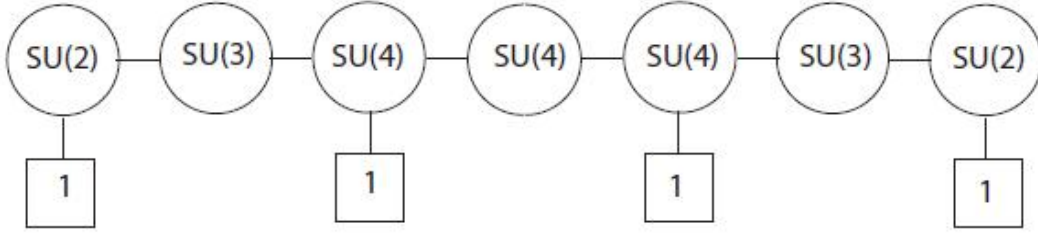

Figure 4-9: An example of a general quiver with only $U(1)$ flavor subgroups for $N = 4$ (this figure is taken from [28]).

to $SU(3)$. The collision of $2 < m < N - 1$ will decouple an $SU(m)$, the resulting puncture will have one column of height $N - m$ and m of height 1, flavor subgroup being $S(U(1) \times U(m))$ ((c) of 4-8 for example). If $m > N - 2$ an $SU(N)$ decouples and a maximal puncture should be produced, indeed following from above the Young diagram has N columns of height 1 and flavor $SU(N)$.

Specialising to the case of $SU(N)$, $N_f = 2N$ one should see the emergence of a new dual theory through the generalisation of AS duality called Gaiotto Duality. The associated Riemann surface is $\mathcal{C}_{(2,0,\dots,0,2),0}$. The dual theory will emerge at the $\tau \rightarrow 1$ cusp which corresponds, by comparing with the $N = 3$ case, to the collision of two basic punctures. From above, we know that at this cusp an $SU(2)$ subgroup decouples. This $SU(2)$ is a gauged subgroup of an interacting SCFT with $SU(2) \times SU(2N)$ flavor symmetry. When $N = 3$, $SU(2) \times SU(2N)$ enjoys an enhancement to E_6 but this is unique to this case. Here colliding two basic punctures is equivalent to colliding two maximal punctures. The other possible collision corresponds to the ‘usual’ S-dual weak coupling limits of the $SU(N)$ group.

To study the collision of a basic puncture with a generic puncture, one obviously requires a theory with basic punctures and at least one generic. Such a theory can be constructed by modifying the linear quiver in figure 4-9. The portion with $\prod_{i=2}^{N-1} SU(i)$ is replaced by $\prod_{i=i}^k SU(n_i)$. To remain conformal $2n_i - n_{i-1} - n_{i+1}$, $n_0 = 0$ hypers must be coupled to each $SU(n_i)$ node. The Young diagram for the generic puncture has k rows of length $n_{i+1} - n_i$ see figure 4-10. By colliding a basic puncture

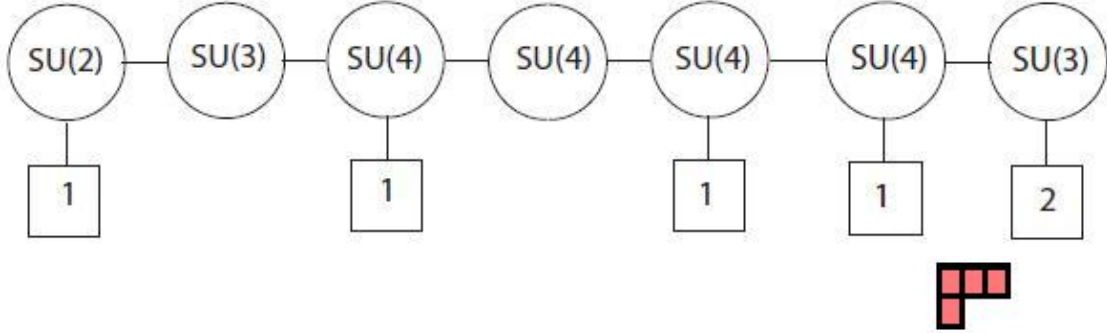

Figure 4-10: A modification of the general quiver in 4-9. The generic puncture is associated to the Young diagram shown

with the generic one $SU(n_1)$ will be decoupled. The resulting quiver will have $SU(n_2)$ at the first node. The puncture produced in this collision has $k - 1$ rows of length $n_{i+1} - n_i$ where now $n_1, n_0 = 0$. The Riemann surface has degenerated into two parts, one with a basic punctures and the ‘new’ generic puncture the other with one basic puncture, the ‘old’ generic puncture and one other which may be irregular. Colliding $s < k + 1$ basic punctures with the generic one will decouple an $SU(n_s)$ and split the quiver in two. From the point of view of the longer quiver a generic puncture has been produced, the Young diagram of which has $k - s$ rows the first of which has length n_s . If $s > k$ an $SU(N)$ decouples leaving a maximal puncture.

As with the case of $\mathcal{T}_{(f_1, f_3), g}[A_2]$, a generic cusp of $\mathcal{T}_{(f), g}[A_{n-1}]$ will correspond to the maximal degeneration of $\mathcal{C}_{(f_1, f_3), g}$ to a collection of three punctured spheres. The spheres are arranged in a graph with g loops, the connections between the spheres represent the gauge groups that have been weakly coupled.

4.1.11 SW Curves

We now look to confirm the above arguments using SW curves. The simplest SW curve that can be considered is that of massless $SU(N)$, $N_f = 2N$

$$v^N t^2 + c_1(v^n - u^{(2)}v^{n-2} - \dots - u^{(n)})t + c_{n+1}v^N = 0 \quad (4.46)$$

or with $v = tx$

$$x^N = \sum_{k=2}^N \frac{u^{(k)}}{(t-1)(t-t_1)t^{k-1}} x^{N-k} \quad (4.47)$$

The poles of the differentials $\phi_i dz^i$ at $t = 1, t_1$ are thus of the order $p_i = 1, \forall i$ while for $t = 0, \infty$ $p_i = i - 1$. To associate these to basic and maximal punctures respectively requires the mass deformed curve

$$\prod_{i=1}^N (v - m_i) t^2 + c_1 (v^N - u^{(2)} v^{N-2} - \dots - u^{(N)}) t + c_2 \prod_{j=N+1}^{2N} (v - m_j) \quad (4.48)$$

After collecting powers of v

$$V^N = \frac{M_2(t)}{(t-1)(t-t_1)} v^{N-1} + \sum_i \frac{U^{(i)}(t)}{(t-1)(t-t_1)} v^{N-i} \quad (4.49)$$

As $t \rightarrow \infty$ $v_\alpha \sim (m_1 + \mathcal{O}(1/t), m_2 + \mathcal{O}(1/t), m_3 + \mathcal{O}(1/t), \dots)$ and for $t \rightarrow 0$ $v_\alpha \sim (m_{N+1} + \mathcal{O}(t), m_{N+2} + \mathcal{O}(t), m_{N+3} + \mathcal{O}(1/t), \dots)$. Thus λ has poles on all branches of v at $t = 0, \infty$ but only on a single branch for $t = 1, t_1$. A shift of v that eliminates the term v^{N-1} ensures poles on all branches at all punctures and that their residues sum to zero. The residues are of the form $((N-1)m, -m, -m, \dots, -m)$ at $t = 1, t_1$ and $(\sum_i m_i, -m_1, \dots, -m_{n-1})$ at $t = 0, \infty$. The punctures are therefore basic and maximal, associated to $U(1)$ and $SU(N)$. After the shift and a fractional linear transformation get 4.45 with $(x, z) \in \mathbb{T}^* \mathcal{C}_{(2,0,\dots,0,2)}, 0$.

By sending $t_1 \rightarrow 1$ the generalised AS dual theory should emerge. If $u^{(2)} = 0$ one gets the curve for the $SU(2) \times SU(2N)$ interacting SCFT

$$x^N = \sum_{k=3}^N \frac{u^{(k)}}{(t-1)^2 t^{k-1}} x^{N-k} \quad (4.50)$$

The associated Riemann surface is a sphere with two maximal punctures and one with $p_i = \{1, 2, 2, \dots\}$ labelled by a Young diagram with one column of height $N - 2$ and two of height 2 (for $N = 3$ there are three maximal punctures). This three punctured sphere will form part of the collection of spheres which correspond to a generic cusp

of $\mathcal{T}_{(f),g}[A_{n-1}]$.

For the theory with one generic puncture and the rest basic the SW curve is constructed in a similar manner to 4.31.

$$\begin{aligned} & v^N t^{n+1} c_1 v^{N-n_1} (v^{n_1} - u_1^{(2)} v^{n-2} - \dots) t^n + c_2 V^{N-n_2} (v^{n_2} - \dots) t^{n-1} + \dots \\ & + c_{k+1} (v^N - u_{k+1}^{(2)} v^{n-2} - \dots) t^{n-k+1} + \dots + c_{n-1} (v^3 - u_{n-1}^{(2)} v - u_{n-1}^{(3)}) t^2 \\ & + c_n v^{N-2} (v^2 - u_n^{(2)}) t + c_{n+1} v^N = 0 \end{aligned}$$

The coefficients of $u_d^{(i)}$ have factors of t^k , $i-1 \leq k \leq n$ up to $i \leq n_1$. For $u_d^{(n_i)}$ however $n_i - 1 \leq k \leq d_i$ where $d_i = n + 1 - s$ for $n_{s-1} \leq i \leq n_s$. Therefore the curve can be rearranged

$$\prod_{\alpha} (t - t_{\alpha}) x^N = \sum_{i=2}^N U_{d_i-i+1}^{(i)} t^{-1} x^{N-i} \quad (4.51)$$

One sees that $t = 0, t_{\alpha}$ are basic punctures and that $\phi_i(t) dt^i$ have poles at $t = \infty$ of order $p_i = \{1, 2, \dots, n_1, n_1, \dots, n_2 - n_1 - 1, n_2 - n_1 - 1, \dots\}$. Such a pole structure is given by the Young diagram attributed to this puncture in the last section.

4.1.12 M Theory

All the SW curves encountered thus far in this chapter were constructed by considering type IIA brane configurations without D6s, the extra hypers at certain nodes coming semi infinite D4s. The configurations are such, that at the origin of the Coulomb branch and for zero masses they consist of N infinite D4s intersected at points in x^6 by a number of NS5s. The M theory uplift of this configuration is N coincident M5s wrapping a two punctured Riemann sphere being intersected by transverse M5s wrapping \mathbb{C}_v . This is opposed to the previously seen single M5 wrapping Σ_{SW} , the later, however, is a deformation of the first. In the limit where the transverse M5 physics decouples they appear only as codimension 2 defects on the w.v. of the coincident branes or punctures on the Riemann sphere. Thus $\mathcal{T}_{(f),g}[A_{n-1}]$ are the low energy limits of N coincident M5s wrapping $\mathcal{C}_{(f),g}$. This tallies with the new realisation of the SW curve as an N -sheeted cover of $\mathcal{C}_{(f),g}$.

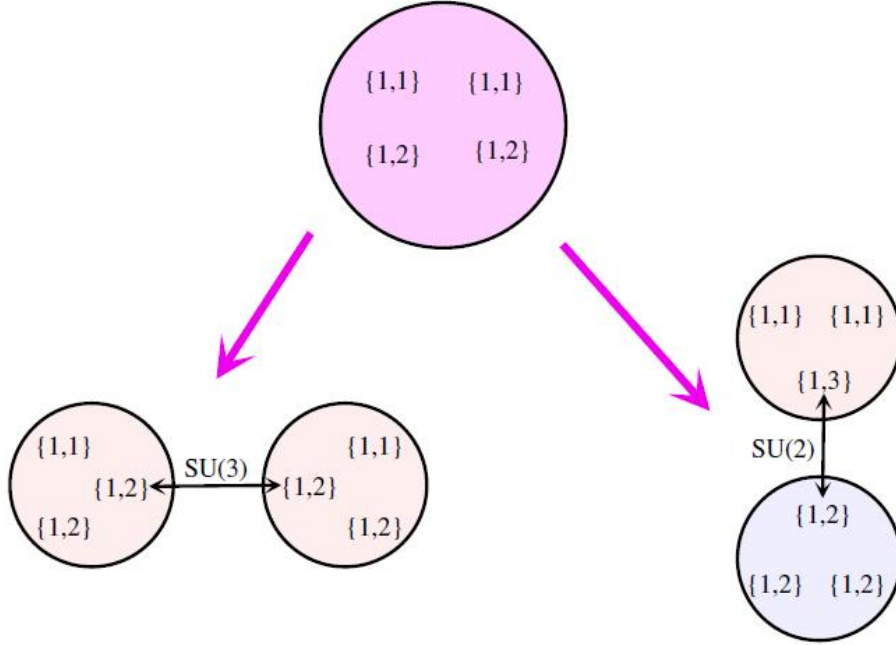

Figure 4-11: The two possible degenerations of a four punctured sphere. Both represent S-dual weak coupling cusps of $\mathcal{T}_{(2,2),0}[A_2]$ (this figure is taken from [29])

Alternatively, one could consider the $(2, 0)$ A_{N-1} 6d theory compactified on $\mathcal{C}_{(f),g}$. Performing a KK reduction, in such a way as to preserve $\mathcal{N} = 2$ supersymmetry, will result in $\mathcal{T}_{(f),g}[A_{n-1}]$.

4.2 Tinkertoys

A generic cusp of any $\mathcal{T}_{(f),g}[A_{N-1}]$ corresponds to the degeneration of $\mathcal{C}_{(f),g}$ to a collection of three punctured spheres, hereafter referred to as fixtures, arranged in a graph with g loops. These fixtures when considered individually may correspond to either free or interacting theories. The connections between fixtures, hereafter called cylinders, join a pair of punctures, one on each sphere, and represent a gauge group that is weakly coupled at that cusp. These can be $SU(m)$, $m = 2, \dots, N$ or sometimes other classical groups.

All possible degenerations of the original Riemann surface $\mathcal{C}_{(f),g}$ to such a collection of fixtures and cylinders represent all possible S-dual cusps of $\mathcal{T}_{(f),g}[A_{N-1}]$, see figure 4-11 for an example with $N = 3$.

By cataloguing the different fixtures and cylinders and formulating a set of rules governing how they fit together one can construct all possible A_{N-1} theories. To state this set of rules requires the notion of irregular punctures.

4.2.1 Irregular Punctures

An irregular puncture is one to which a Young diagram can not be assigned but which nevertheless has an allowable pole structure and set of residues. An example of such a puncture has already been encountered in the previous section. The collision of two basic punctures in $\mathcal{M}_{(n+3,0),0}$ corresponded to the degeneration $\mathcal{C}_{n+3,0} \rightarrow \mathcal{C}_{n+1,0} \times \mathcal{C}_{3,0}$ and the production of a maximal puncture on one side and an irregular puncture on the other. This particular example will be discussed in more detail later. In general an irregular puncture satisfies the following

1. $p_1 = 0, p_2 = 1$
2. $\max(k-1, p_{k-1}) \leq p_k \leq \min(2k-3, p_{k-1}+2)$
3. $\sum_{k=1}^N p_k > N(N-1)/2$
4. \exists a conjugate pole structure $\{p'_k\}$ defined by

$$p'_k = \begin{cases} p_k & \text{if } p_k = k-1 \\ 2k-1-p_k & \text{if } p_k > k-1 \end{cases}$$

that is regular

The flavor symmetry associated to an irregular puncture is given by the subset $\{p_{k'}\} \subset \{p_k\}$ that satisfy $p_{k'} = k' - 1$. The integers k' then give the dimension of the Casimirs of the flavor subgroup. For example $p_k = \{1, 2, 3, 5\}$ has $k' = 2, 3, 4$ is associated to $SU(4)$ while $p_k = \{1, 3, 3, 5\}$ has $k' = 2, 4$ giving $Sp(4)$.

4.2.2 Fixtures

Not all three punctured spheres are fixtures. For example one cannot have a fixture with three basic punctures for $N > 2$ as no collision of punctures can produce a basic puncture. The dimension of the Coulomb branch for a three punctured is $d_S = \sum_k d_k$ where d_k is given by 4.30. If $d_k = 0, \forall k$ then the sphere corresponds to a free theory or an interacting theory otherwise. A free theory obeys

$$2k - 1 = \sum_{i=1} p_k^{(i)} \quad (4.52)$$

If one puncture is basic then $p_k^{(2)}, p_k^{(3)} = k - 1$, the other two punctures are maximal. This the fixture that results after colliding a basic and maximal puncture. It is a free theory of N^2 hypers in the (N, N) representation of $SU(N) \times SU(N)$. The collision of two basic punctures always results in a free fixture the third puncture in the fixture is determined by 4.52 to be $p_k = 2k - 3$. It has two hypers transforming in the fundamental of the $SU(2)$ coming from this third puncture. The sphere previously identified with an interacting $SU(2) \times SU(2N)$ SCFT has two maximal punctures and one with $p_k = 1, 2, \dots, 2$ and indeed $d = N - 2$.

4.2.3 Cylinders

Cylinders are not universal, they can only connect certain pairs of punctures. To be able to connect a pair the reverse process must exist. If a collision of punctures results in a gauge group G_T being decoupled and the production of punctures with pole structure $\{s_k\}, \{r_k\}$ then these two punctures can be connected by a G_T cylinder.

In addition to this the dimension of the Coulomb branch must be unchanged after the degeneration of the Riemann surface. Consider the coalescence of two punctures $\{p_k\}, \{p'_k\}$ resulting in the degeneration of the Riemann surface to a fixture, S , a cylinder, T , and the remainder of the surface C . S has punctures $\{p_k\}, \{p'_k\}, \{s_k\}$, C has, among others, $\{r_k\}$ and T connects $\{s_k\}$ and $\{r_k\}$. The Coulomb branch

dimension due to S is

$$d_S = N - 1 - 2 \sum_{k=2}^N + \sum_k p_k + p'_k + s_k \quad (4.53)$$

The requirement that the dimension does not change amounts to

$$d_S + \text{rank}(G_T) + \sum r_k = \sum p_k + p'_k \quad (4.54)$$

$\Rightarrow \text{rank}(G_T) = N^2 - 1 - \sum s_k + r_k$. The rules for a cylinder connecting two punctures $\{s_k\}$ and $\{r_k\}$ are the following;

1. denoting $q_k = \min(s_k, r_k)$, $\{q_k\}$ is regular
2. $G_T \subset G_{q_k}$ where G_{q_k} is the flavor associated to a $\{q_k\}$ puncture
3. $\text{rank}(G_T) = N^2 - 1 - \sum s_k + r_k$
4. either $s_k = r_k = k - 1$ or $s_k + r_k = 2k - 1$
5. the Casimir dimensions of G_T are the set of integers k such that $s_k = r_k = k - 1$

By colliding basic punctures with all other a free fixture is produced with the third puncture being determined by 4.52 all fixtures containing a basic puncture are found. After this one can collide the next simplest puncture $p_k = \{1, 2, 2, \dots, 2\}$ with all other types, proceeding in this manner a full catalogue of all possible fixtures can be produced. All possible cylinders are found by systematically considering all pairs of regular and irregular punctures.

4.2.4 Example: $SU(3)$

As an example we look to construct all possible A_2 theories. There are two types of regular puncture, the basic, $\{1, 1\}$ and the maximal, $\{1, 2\}$ in addition there is a single irregular puncture $\{1, 3\}$. This was already shown to exist, being the result of the collision of two basic punctures. Using the rules for irregular punctures one sees

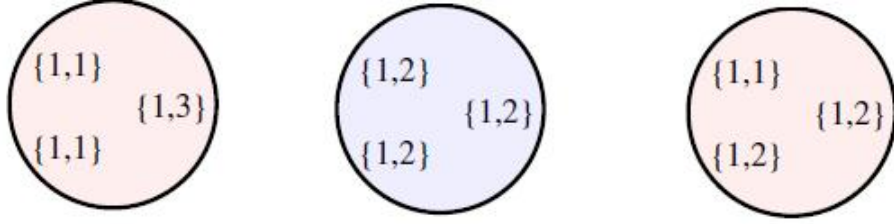

Figure 4-12: The three fixtures for used in the construction of $\mathcal{T}_{(f_1, f_3), g}[A_2]$. The pink sphere on the left is a free theory of two hypers, the sphere on the right is also free and has four hypers. The middle sphere is the interacting E_6 SCFT

this is the only irregular puncture. There are three possible fixtures 4-12 and two cylinders

$$\{1, 2\} \longleftrightarrow \{1, 2\} \tag{4.55}$$

$$\{1, 3\} \longleftrightarrow \{1, 2\} \tag{4.56}$$

4.55 is related to $SU(3)$ and 4.56 to $SU(2)$

5. Conclusion

The aim of this dissertation was to study Seiberg-Witten curves, their appearance in string theory and applications of them in modern research. In Chapter 2 the original work of Seiberg and Witten, relating the Coulomb branch of an $\mathcal{N} = 2$ super Yang Mills theory to a family of elliptic curves that describe genus 1 Riemann surfaces, was reviewed. We then saw that this relationship could be extended to higher rank classical gauge groups with or without matter, the curves this time being hyperelliptic and describing higher genus surfaces. In Chapter 3 brane configurations of Type IIA string theory were used to construct such Seiberg-Witten gauge theories. From this perspective the curves were given a physical interpretation: the M theory uplift of the configuration is an M5 brane wrapping the surface described by the curve. Using this string theory picture allows a more intuitive construction of SW curves as well as enabling one to find curves for product gauge groups. The last chapter reviews more recent work which relies on SW curves. We saw that, to certain SCFTs one can associate punctured Riemann surfaces. The moduli space of such surfaces is the coupling space of the theory and different collisions of punctures corresponded to different dual weak coupling cusps of the theory. Entering a generic cusp of the theory causes the Riemann surface to degenerate to a collection of spheres with three punctures each. These spheres then served as building blocks with which to construct a range of new SCFTs.

In the future it would be nice to further study the subject of Gaiotto duality and tinkertoys. Recent work extending this subject to include the D_N series [30] and attempts to incorporate exceptional groups [31] indicate that there are many interesting avenues to explore.

While this dissertation attempted to cover many of the different aspects and uses of SW curves it is by no means comprehensive. Due to time constraints some sections needed to be shortened, those concerning the inclusion of matter and other classical gauge groups in chapter two but in particular the sections on elliptic models and tinkertoys deserved lengthier discussions. Having said this, it is hoped that this dissertation provides a good introduction to SW curves and would serve as a helpful starting point to those seeking to conduct research along the lines of Gaiotto duality and tinkertoys.

Bibliography

- [1] N. Seiberg and E. Witten, *Electric - magnetic duality, monopole condensation, and confinement in $N=2$ supersymmetric Yang-Mills theory*, Nucl. Phys. B **426**, 19 (1994) [Erratum-ibid. B **430**, 485 (1994)] [hep-th/9407087].
- [2] N. Seiberg and E. Witten, *Monopoles, duality and chiral symmetry breaking in $N=2$ supersymmetric QCD*, Nucl. Phys. B **431**, 484 (1994) [hep-th/9408099].
- [3] P. C. Argyres and A. E. Faraggi, *The vacuum structure and spectrum of $N=2$ supersymmetric $SU(n)$ gauge theory*, Phys. Rev. Lett. **74**, 3931 (1995) [hep-th/9411057].
- [4] A. Klemm, W. Lerche, S. Yankielowicz and S. Theisen, *Simple singularities and $N=2$ supersymmetric Yang-Mills theory*, Phys. Lett. B **344**, 169 (1995) [hep-th/9411048].
- [5] A. Klemm, W. Lerche, S. Yankielowicz and S. Theisen, *On the monodromies of $N=2$ supersymmetric Yang-Mills theory*, In *Warsaw 1994, Proceedings, Physics from Planck scale to electroweak scale* 433-446, and CERN Geneva - TH.-7538 (94/12,rec.Jan.95) 15 p. Muenchen U. - LMU-TPW-94-22 (94/12,rec.Jan.95) 15 p [hep-th/9412158].
- [6] M. R. Douglas and S. H. Shenker, *Dynamics of $SU(N)$ supersymmetric gauge theory*, Nucl. Phys. B **447**, 271 (1995) [hep-th/9503163].
- [7] P. C. Argyres and M. R. Douglas, *New phenomena in $SU(3)$ supersymmetric gauge theory*, Nucl. Phys. B **448**, 93 (1995) [hep-th/9505062].

- [8] U. H. Danielsson and B. Sundborg, *The Moduli space and monodromies of $N=2$ supersymmetric $SO(2r+1)$ Yang-Mills theory*, Phys. Lett. B **358**, 273 (1995) [hep-th/9504102].
- [9] A. Brandhuber and K. Landsteiner, *On the monodromies of $N=2$ supersymmetric Yang-Mills theory with gauge group $SO(2n)$* , Phys. Lett. B **358**, 73 (1995) [hep-th/9507008].
- [10] P. C. Argyres, M. R. Plesser and A. D. Shapere, *The Coulomb phase of $N=2$ supersymmetric QCD*, Phys. Rev. Lett. **75**, 1699 (1995) [hep-th/9505100].
- [11] A. Hanany and Y. Oz, *On the quantum moduli space of vacua of $N=2$ supersymmetric $SU(N(c))$ gauge theories*, Nucl. Phys. B **452**, 283 (1995) [hep-th/9505075].
- [12] A. Hanany, *On the quantum moduli space of vacua $N=2$ supersymmetric gauge theories*, Nucl. Phys. B **466**, 85 (1996) [hep-th/9509176].
- [13] P. C. Argyres and A. D. Shapere, *The Vacuum structure of $N=2$ superQCD with classical gauge groups*, Nucl. Phys. B **461**, 437 (1996) [hep-th/9509175].
- [14] P. C. Argyres, *S duality and global symmetries in $N=2$ supersymmetric field theory*, Adv. Theor. Math. Phys. **2**, 293 (1998) [hep-th/9706095].
- [15] P. C. Argyres and A. Buchel, *Deriving $N=2$ S - dualities from scaling for product gauge groups*, Phys. Lett. B **431**, 317 (1998) [hep-th/9804007].
- [16] P. C. Argyres and A. Buchel, *New S dualities in $N=2$ supersymmetric $SU(2) \times SU(2)$ gauge theory*, JHEP **9911**, 014 (1999) [hep-th/9910125].
- [17] C. Vafa, *Geometric origin of Montonen-Olive duality*, Adv. Theor. Math. Phys. **1**, 158 (1998) [hep-th/9707131].
- [18] A. Hanany and E. Witten, *Type IIB superstrings, BPS monopoles, and three-dimensional gauge dynamics*, Nucl. Phys. B **492**, 152 (1997) [hep-th/9611230].
- [19] E. Witten, *Solutions of four-dimensional field theories via M theory*, Nucl. Phys. B **500**, 3 (1997) [hep-th/9703166].

- [20] A. Giveon and D. Kutasov, *Brane dynamics and gauge theory*, Rev. Mod. Phys. **71**, 983 (1999) [hep-th/9802067].
- [21] A. Mikhailov, *BPS states and minimal surfaces*, Nucl. Phys. B **533**, 243 (1998) [hep-th/9708068].
- [22] A. Fayyazuddin and M. Spalinski, *The Seiberg-Witten differential from M theory*, Nucl. Phys. B **508**, 219 (1997) [hep-th/9706087].
- [23] M. Henningson and P. Yi, *Four-dimensional BPS spectra via M theory*, Phys. Rev. D **57**, 1291 (1998) [hep-th/9707251].
- [24] K. Landsteiner, E. Lopez and D. A. Lowe, *$N=2$ supersymmetric gauge theories, branes and orientifolds*, Nucl. Phys. B **507**, 197 (1997) [hep-th/9705199].
- [25] K. Landsteiner and E. Lopez, *New curves from branes*, Nucl. Phys. B **516**, 273 (1998) [hep-th/9708118].
- [26] A. M. Uranga, *Towards mass deformed $N=4$ $SO(n)$ and $Sp(k)$ gauge theories from brane configurations* Nucl. Phys. B **526**, 241 (1998) [hep-th/9803054].
- [27] P. C. Argyres and N. Seiberg, *S-duality in $N=2$ supersymmetric gauge theories*, JHEP **0712**, 088 (2007) [arXiv:0711.0054].
- [28] D. Gaiotto, *$N=2$ dualities*, [arXiv:0904.2715].
- [29] O. Chacaltana and J. Distler, *Tinkertoys for Gaiotto Duality*, JHEP **1011**, 099 (2010) [arXiv:1008.5203 [hep-th]].
- [30] O. Chacaltana and J. Distler, *Tinkertoys for the D_N series*, [arXiv:1106.5410 [hep-th]].
- [31] O. Chacaltana, J. Distler and Y. Tachikawa, *Nilpotent orbits and codimension-two defects of $6d$ $N=(2,0)$ theories*, [arXiv:1203.2930 [hep-th]].

- [32] L. Alvarez-Gaume and S. F. Hassan, *Introduction to S duality in N=2 supersymmetric gauge theories: A Pedagogical review of the work of Seiberg and Witten*, Fortsch. Phys. **45**, 159 (1997) [hep-th/9701069].
- [33] W. Lerche, *Introduction to Seiberg-Witten theory and its stringy origin*, Nucl. Phys. Proc. Suppl. **55B**, 83 (1997) [Fortsch. Phys. **45**, 293 (1997)] [hep-th/9611190].
- [34] J. Terning, *Modern Supersymmetry: Dynamics And Duality* (Oxford University Press, 2006).
- [35] N. Koblitz, *Introduction To Elliptic Curves And Modular Forms* (Springer-Verlag, 1984)