



## Wayfinding Guidelines

Revision E: 30th September 2010

## contents

introduction	3
hierarchy principles	4
Equality Act 2010 criteria	5
campus maps (combined)	6
campus maps (high and low)	7
directional signs	8
walkway signs	9
electronic signs	10
accessible route	11
external directional (wall)	12
internal directional (wall)	13
floor directory (wall)	14
notice boards	15
door signs (standard)	16
door signs (residences)	17
door signs (non standard)	18
paper notice holders	19
sign positioning	20

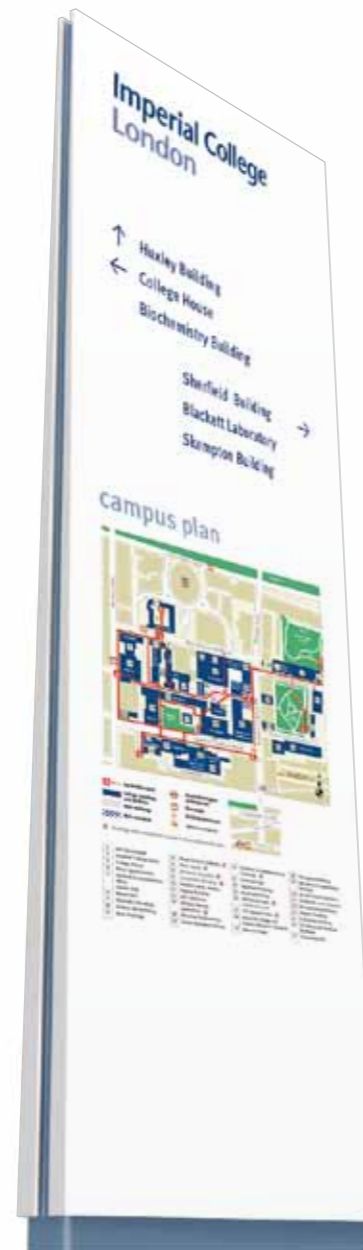

## introduction

The following pages represent an approved family of wayfinding signs for Imperial College London. They have been designed to orientate staff, students and campus visitors to a final campus destination of their choice as efficiently and as easily as possible.

## wayfinding strategy

The development of the signage strategy has been based upon measurements of usability and inclusivity.

This means that clearly defined external accessible routes have been established at each campus that enable the user to locate a building of their choice. Then, via internal signage to navigate to the appropriate point within that building.

## hierarchy principle

Only relevant information within the vicinity of each sign location is displayed on the sign. The format of the information is also very consistent. This ensures that wayfinding is clear (for the visually impaired) & keeps the number of signs to a minimum.

## sign design

The design of the signage has been carefully considered to enhance the University's brand image whilst utilising best practice associated with the Equality Act 2010.

External signage is predominantly white which is the preferred background colour for the University brand and is a strong contrast to the majority of University building facades. Internally most walls are light coloured so all interior signs have a dark blue (pms 541) background with white text.

## the brand

The brand logo is always positioned in the top left hand corner of the sign and spaced away from other elements using a minimum exclusion area (detailed in the Imperial College London Brand Guidelines). Highlight colours have been kept to a minimum and are taken from the primary corporate palette. Supporting information is in black for best contrast against the white background.

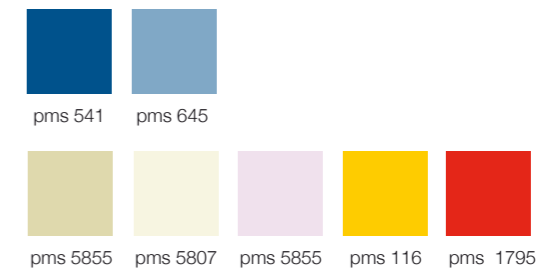

## other images

Where other images are used on signage they must be taken from the Imperial College image library. If an Imperial College London logo is used on an image or coloured background it should be solid white. Other institutions branded logos should not be used on Imperial College London wayfinding signs.

MetaPlusMedium Roman is the only font to be used on signage. It is a corporate font chosen for its legibility. Italic or bold lettering must not be used as the visually impaired find them difficult to read.

**AaBbCcDdEeFfGgHhIiJjKkLlMm**  
**NnOoPpQqRrSsTtUuVvWwXxYyZz**  
MetaPlusMedium Roman

## sign construction

Construction principles are based around a tried and tested modular component system which offers very robust, city centre signs, with hidden security features, easily changeable panels and graffiti resistant lacquered surfaces.

exterior sign hierarchy principles

A.

**Imperial College London**

← Low level route through campus starts across the other side of Imperial College Road

campus plan

1. Accessible route  
 2. College buildings and facilities  
 3. Main walkway  
 4. Main entrance  
 5. Buildings where wheelchair access is not possible at this time  
 6. Accessible routes are indicated at this time

1. Best Quarrange	22. Royal School of Mines	39. Institute for Mathematical Sciences	56. Stempson Building
2. Imperial College Union	23. Rossmore Building	40. Linnell Hall	57. Mechanical Engineering Building
3. College House	24. Concorde Building	41. Shephard Building	58. Health Physics Centre
4. Alton Market Centre	25. Health Centre, Dental	42. Faculty Building	59. Southside Lane
5. Student Accommodation	26. Huxley Building	43. Conference Link	60. Biochemistry Building
6. Olden Hall	27. ACE Extension	44. 58 Prince's Gate	61. Flowers Building
7. Weeks Hall	28. William Perrey	45. 179 Queen's Gate	62. Chemistry Building
8. Blackett Laboratory	29. Librarians	46. Imperial College and Science Museum Libraries Building	63. Sir Alexander Fleming Building
9. Roderic Hill Building	30. Electrical Engineering	47. Queen's Tower	64. Chemistry RCS
10. Howe Building	31. Tenika Business School		

signs direct people along clearly defined accessible routes (see red lines)

B.

**Imperial College London**

↑ Falmouth Gate

← Flowers Building

← Chemistry / Biochemistry Building

Library →

Sherfield Building →

♿ accessible route

generally only information relating to buildings in close proximity to the sign location are shown on the sign

C.

↑ 1.

← 2.

↓ 3.

6. ↗

5. →

4. ↘

an arrow hierarchy is detailed on all directional signs & this comprises of the 1-6 order sequence, above.

D.

↑ Chemistry / Biochemistry Building

Flowers Building

Library

Sherfield Building

← Sir Alexander Fleming Building

Flowers Building ↗

Queen's Lawn

♿ accessible route

within the arrow hierarchy buildings are listed alphabetically.

Equality Act 2010 criteria (used at Imperial College London)

veiwing distances

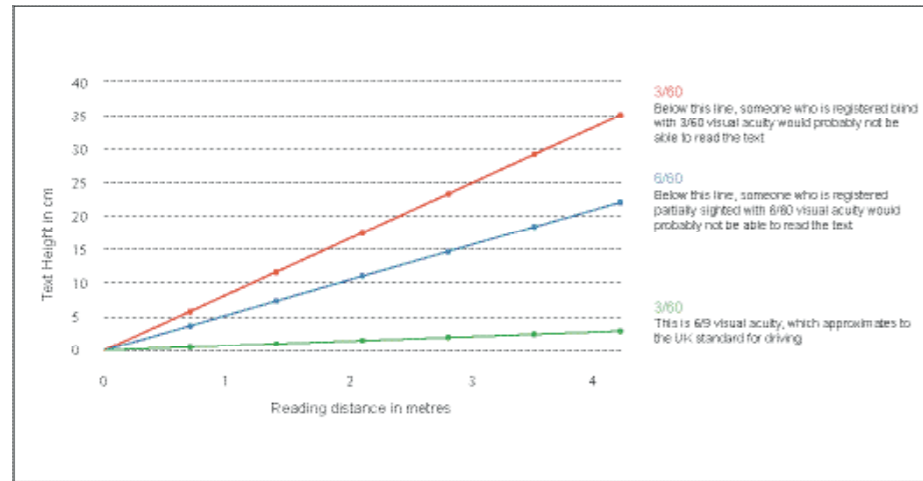

left and right precedence

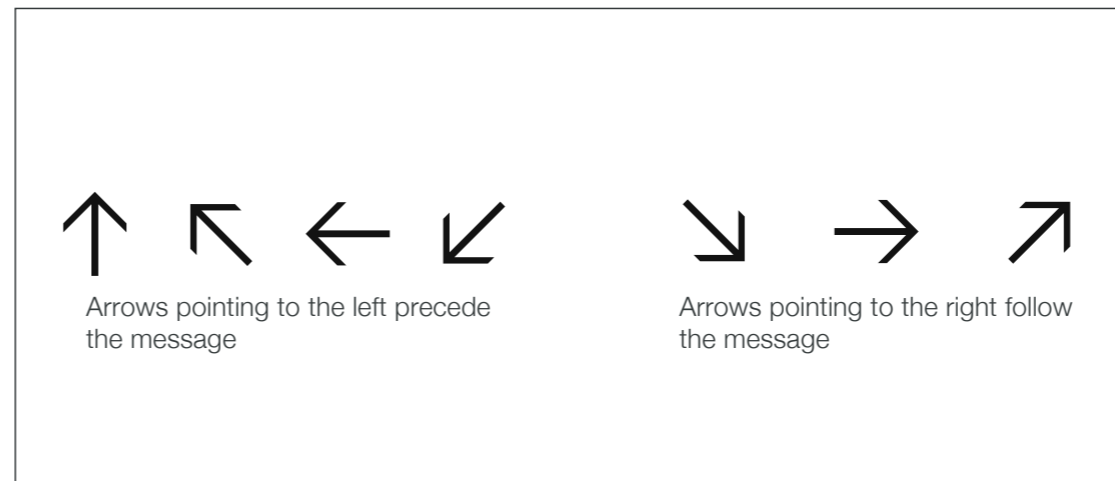

position of arrows

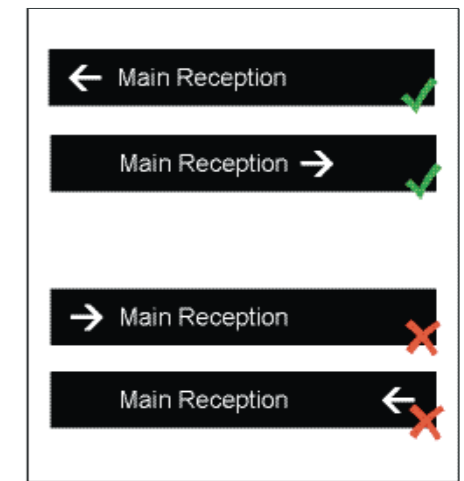

sign content and layout:

Must consider:

- Viewing distances
- Sans serif typeface
- Upper and lower case - not CAPITALS
- Letter spacing
- Minimal use of bold, italics, condensed or lightweight fonts.
- Text tracking
- Consistent font stem widths
- Left justification
- Standard arrows (ISO 7001)
- Borders
- Certain colour selections and tonal contrasts
- Materials
- Tactile/embossed, with or without braille

san serif typefaces

Arial  
1234567890

metaplusmedium  
1234567890

Futura  
1234567890

Helvetica  
1234567890

upper lower not CAPITALS

Car Park  
Offices  
Restaurant ✓

CAR PARK  
OFFICES  
RESTAURANT ✗

tonal contrast (background)

Incorrect background contrast ✗

Correct background contrast ✓

tonal contrast (text)

Incorrect text contrast ✗

Correct text contrast ✓

## campus maps

The campus map was redesigned to reflect the corporate colour palette. It will be updated regularly to reflect ongoing campus developments and now shows accessible routes through the campus (red lines). In preparing this, it was apparent that there are actually three maps needed for South Kensington Campus and each of those will require four orientations, for North, South East and West.

The three map designs comprise of a Low Level route map, High Level (walkway) route map and Combined map. The use of the separate High and Low level maps will be dependant upon sign location, the Combined route map is for website and literature use.

Please see next page for high and low level map designs.

combined high and low level route map

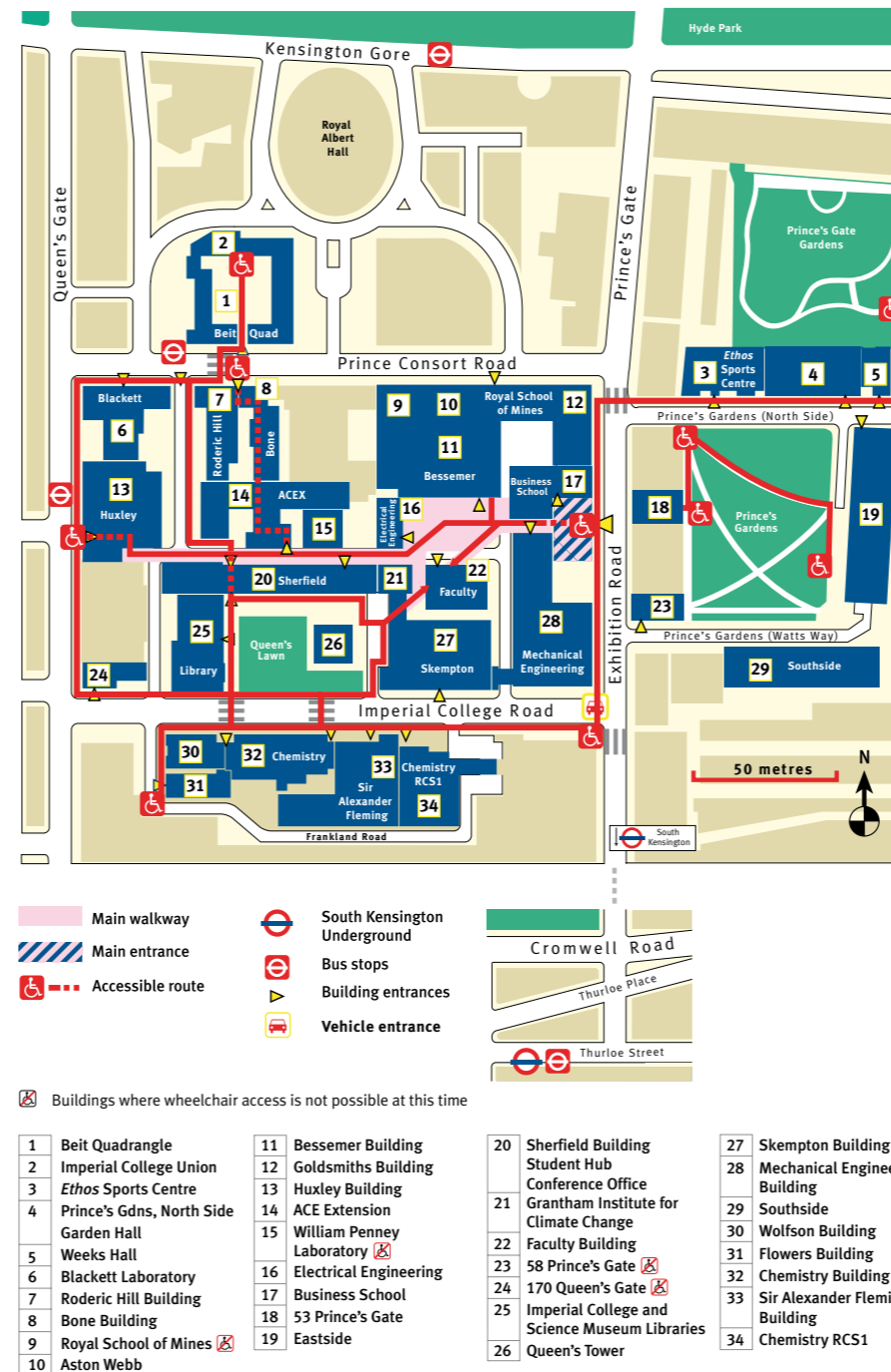

campus maps cont..

high level route map

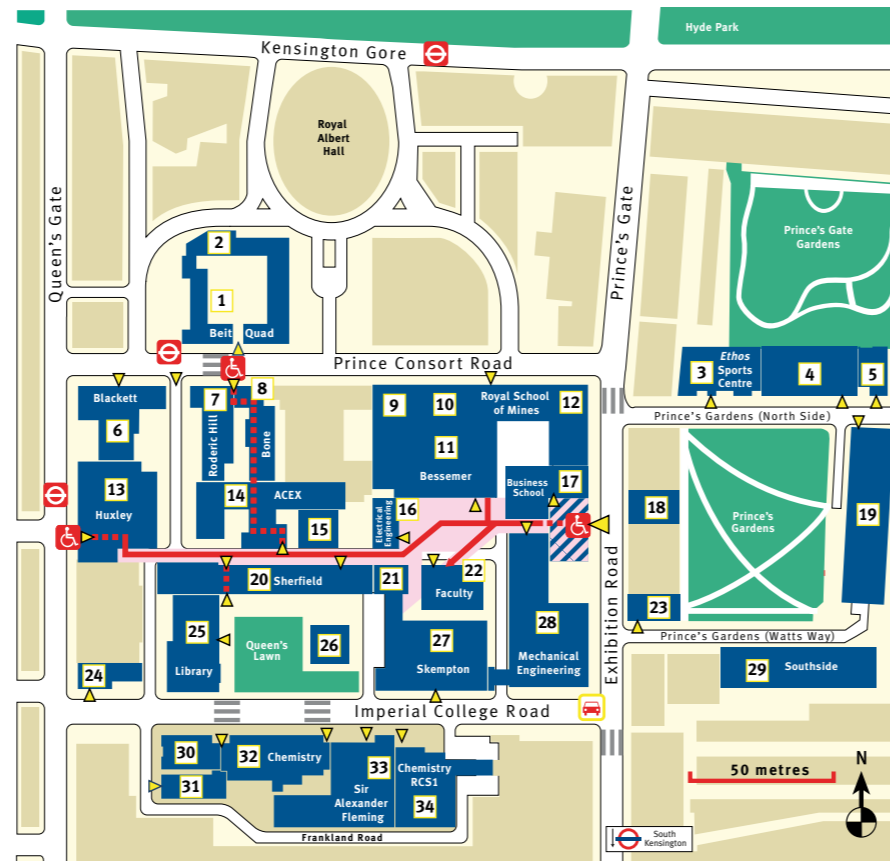

Main walkway  
 Main entrance  
 Accessible route  
 South Kensington Underground  
 Bus stops  
 Building entrances  
 Vehicle entrance

⊗ Buildings where wheelchair access is not possible at this time

- |                             |                              |  |                                    |
|-----------------------------|------------------------------|--|------------------------------------|
| 1 Beit Quadrangle           | 11 Bessemer Building         | 20 Sherfield Building                            | 27 Skempton Building               |
| 2 Imperial College Union    | 12 Goldsmiths Building       | 21 Student Hub                                   | 28 Mechanical Engineering Building |
| 3 Ethos Sports Centre       | 13 Huxley Building           | 22 Conference Office                             | 29 Southside                       |
| 4 Prince's Gdns, North Side | 14 ACE Extension             | 23 Grantham Institute for Climate Change         | 30 Wolfson Building                |
| 5 Garden Hall               | 15 William Penney Laboratory | 24 Faculty Building                              | 31 Flowers Building                |
| 6 Weeks Hall                | 16 Electrical Engineering    | 25 58 Prince's Gate                              | 32 Chemistry Building              |
| 7 Blackett Laboratory       | 17 Business School           | 26 170 Queen's Gate                              | 33 Sir Alexander Fleming Building  |
| 8 Roderic Hill Building     | 18 53 Prince's Gate          | 27 Imperial College and Science Museum Libraries | 34 Chemistry RCS1                  |
| 9 Bone Building             | 19 Eastside                  | 28 Queen's Tower                                 |                                    |
| 10 Royal School of Mines    |                              |  |                                    |
| 11 Aston Webb               |                              |  |                                    |

low level route map

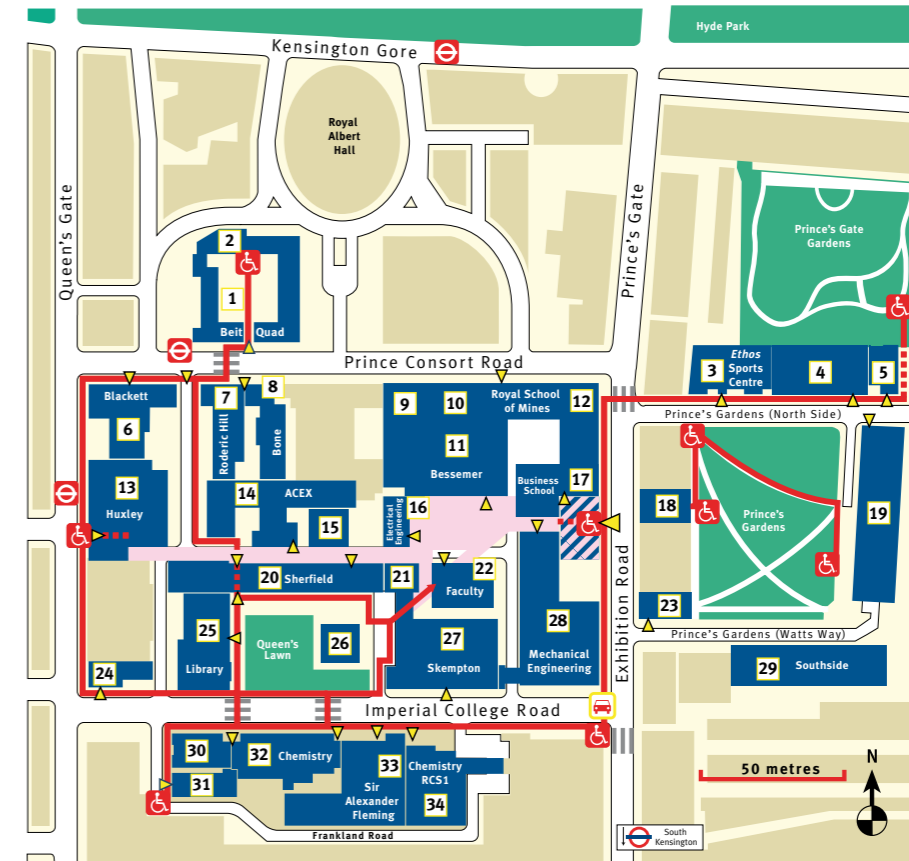

Main walkway  
 Main entrance  
 Accessible route  
 South Kensington Underground  
 Bus stops  
 Building entrances  
 Vehicle entrance

⊗ Buildings where wheelchair access is not possible at this time

- |                             |                              |  |                                    |
|-----------------------------|------------------------------|--|------------------------------------|
| 1 Beit Quadrangle           | 11 Bessemer Building         | 20 Sherfield Building                            | 27 Skempton Building               |
| 2 Imperial College Union    | 12 Goldsmiths Building       | 21 Student Hub                                   | 28 Mechanical Engineering Building |
| 3 Ethos Sports Centre       | 13 Huxley Building           | 22 Conference Office                             | 29 Southside                       |
| 4 Prince's Gdns, North Side | 14 ACE Extension             | 23 Grantham Institute for Climate Change         | 30 Wolfson Building                |
| 5 Garden Hall               | 15 William Penney Laboratory | 24 Faculty Building                              | 31 Flowers Building                |
| 6 Weeks Hall                | 16 Electrical Engineering    | 25 58 Prince's Gate                              | 32 Chemistry Building              |
| 7 Blackett Laboratory       | 17 Business School           | 26 170 Queen's Gate                              | 33 Sir Alexander Fleming Building  |
| 8 Roderic Hill Building     | 18 53 Prince's Gate          | 27 Imperial College and Science Museum Libraries | 34 Chemistry RCS1                  |
| 9 Bone Building             | 19 Eastside                  | 28 Queen's Tower                                 |                                    |
| 10 Royal School of Mines    |                              |  |                                    |
| 11 Aston Webb               |                              |  |                                    |

## directional & campus signs

Directional totems are located at pedestrian intersections. At key pedestrian decision points the appropriate Campus Map is included. All directional signs utilise the hierarchy principle of wayfinding, which means that only buildings within reasonable proximity are shown.

To maintain a concise and consistent approach, departmental information is excluded from directional signs. Only building names are used, which are compatible with the new Campus Map information.

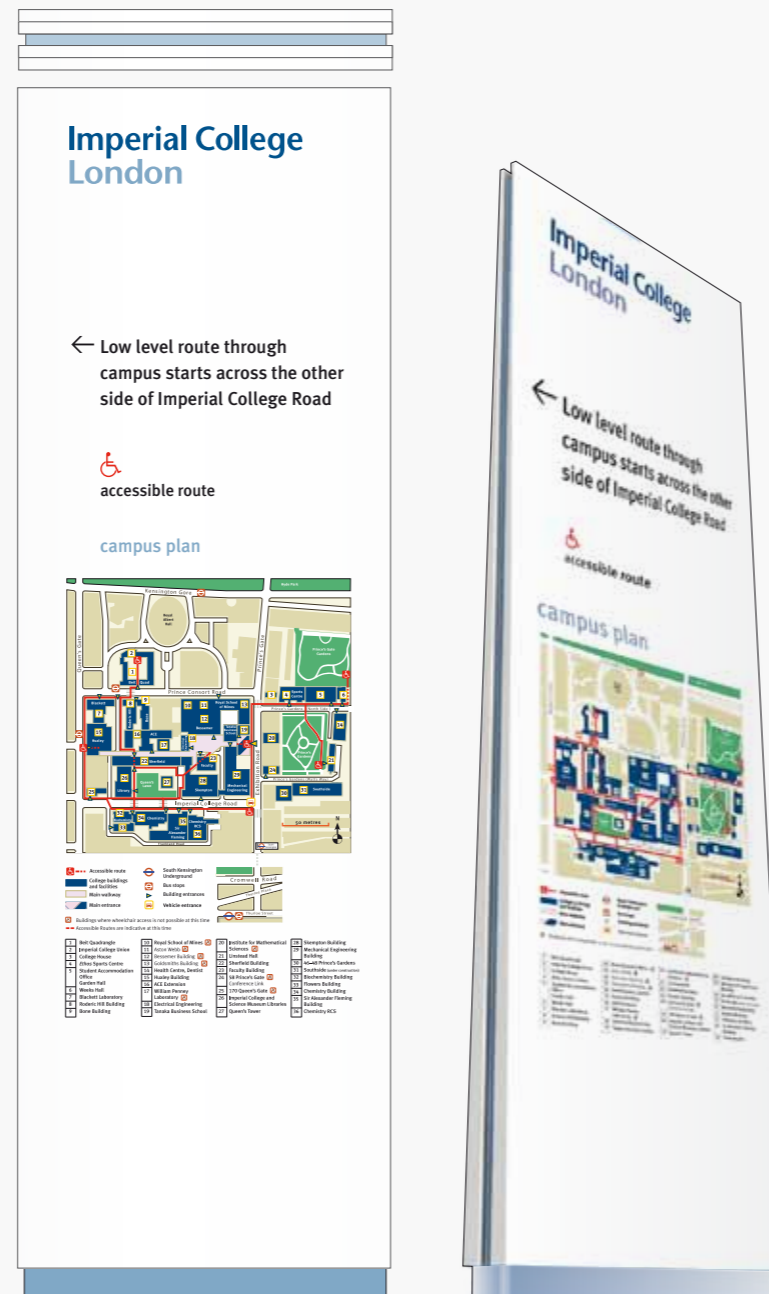

sign type EXT-901

**large directional totem with campus map (double sided)**

**size** - 1200x4000x200mm  
**location** - various locations adjacent to accessible route

**optional features** -

- 1) - tactile paving - assists people with disabilities to locate the sign
- 2) - recessed stainless steel uplighters - with toughened glass lenses, angled reflectors and photocell sensors for night time activation

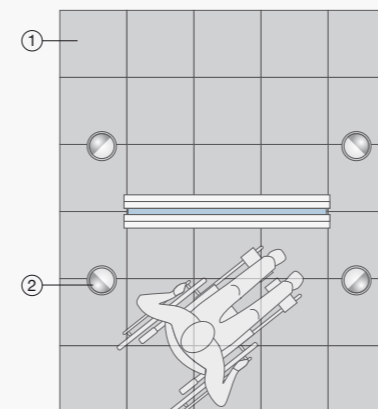

plan view of monolith with additional features

sign type EXT-902

**campus map sign wall mounted**

**size** - 900x1770x40mm  
**location** - inside campus various locations adjacent to accessible wayfinding routes (high and low level)

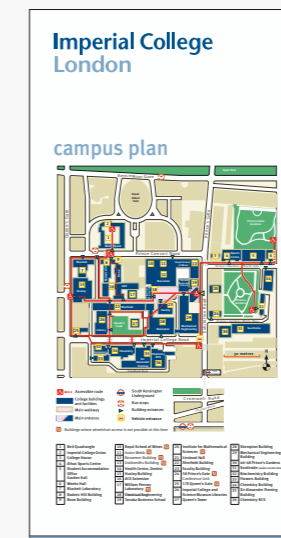

sign type EXT-903

**directional totem**

**size** - 900x2250x100mm  
**location** - inside campus various locations adjacent to accessible wayfinding routes (high and low level)

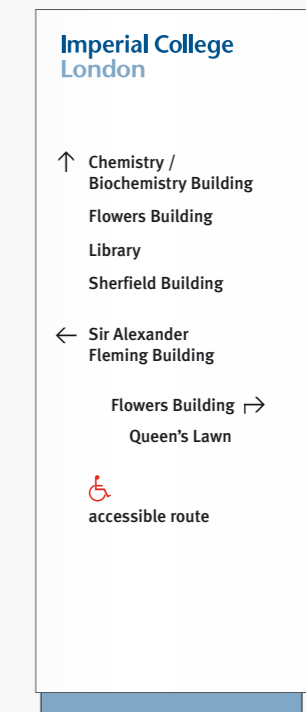

- aluminium monoliths are constructed using 4mm thick aluminium panels supported upon an aluminium box section frame
- map and key to be full colour digital prints
- directional and information text and graphics are to be applied in Self Adhesive Vinyl
- sign framework is to be concreted into the ground



## walkway signs

Some walkway sign panels are made from toughened safety glass, backed with long life digital prints. Other sign boards are made from rigid PVC with a cleanable printed surface to enable students to place notices onto them. The pictorial theme is based upon a student notebook (graphic content designed by Studio Tonne)

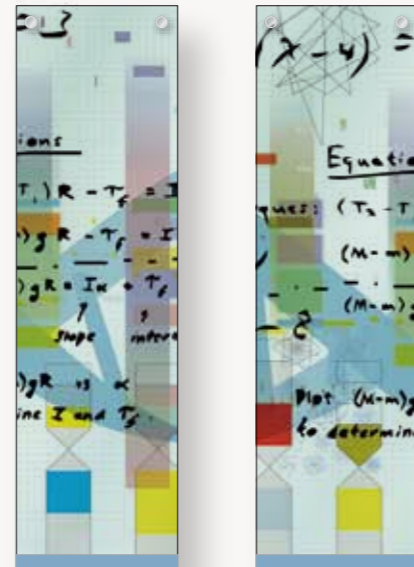

sign type WA-102

### column mounted walkway art

**size** - dependent upon location  
location - columns along walkway

**features** - 10mm toughened glass panels mounted to column using stainless steel stand off locators. Graphics are digitally printed vinyl. Folded dibond panels cover the side of each column and have lockable glass cabinets mounted onto the panels (to be utilised by Imperial College Student Union).

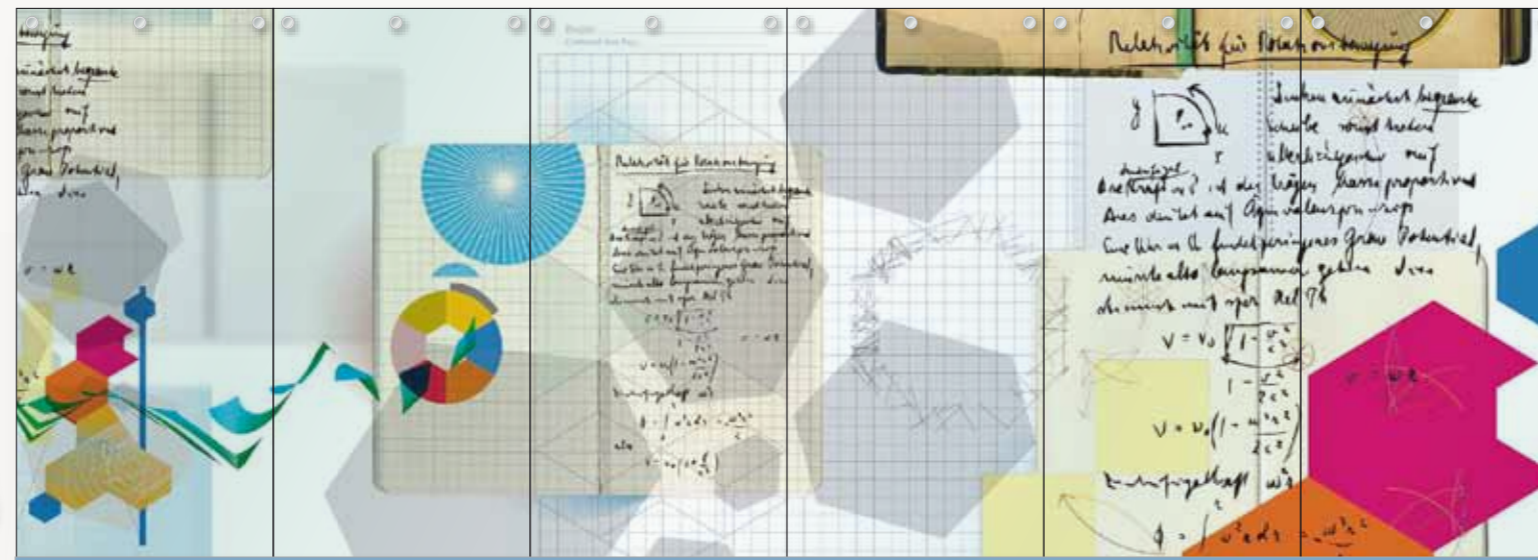
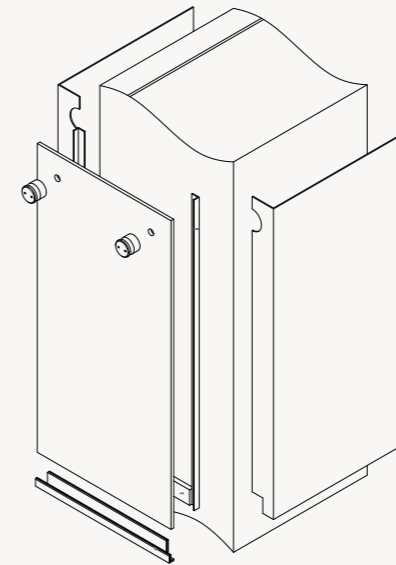

sign type WA-101

### wall mounted walkway art

**size** - dependent upon location  
location - along walkway

**features** - 10mm toughened glass/composite panels mounted to wall using stainless steel stand off locators. Graphics to be digitally printed vinyl applied to rear of glass or face of composite boards.

- 10mm toughened glass / composite panels mounted to wall using stainless steel stand off locators.
- Graphics to be digitally printed vinyl applied to rear of glazing or face of composite panels
- Folded dibond panels to cover side of columns

variable  
messaging  
signage (VMS)

Some University signs require the ability to be instantly updatable in order to keep up with daily changes occurring on campus.

Security issues and conference events are key subjects for variable message boards.

sign type EL-101

**variable messaging - car parks/main entrances**

**size** - 2365x3525mm  
**features** - branded wall panel with electronic information and one way viewing window at the side, updated from central security office



sign type EL-102

**variable messaging - conferencing**

**size** - 1200x2900mm  
**features** - branded monolith structure with electronic information panels updating via a modem link from the Conference Office

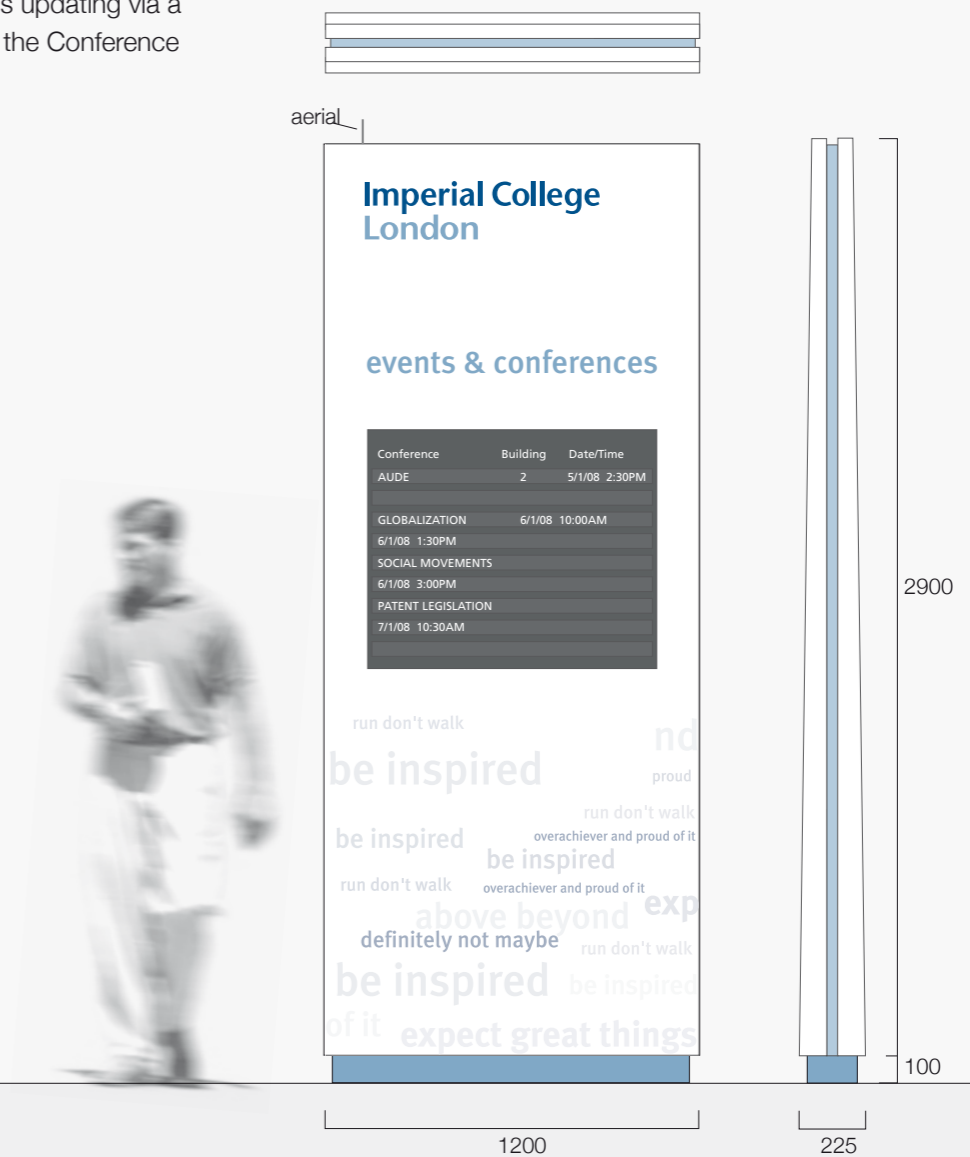

- Information panels to include updatable ultrabrite LED message panels with wireless modem link to remote pc
- Graphics to be digitally printed vinyl wrapped to surface of sign
- Security hut window has contravision one-way vinyl applied to inside of glazing

## accessible route signs

Accessible routes are clearly identified along their length and at the start/end points. These help users maintain their course along safe routes by standardised sign structures that are easily identifiable.

sign type EXT-906

**start/end of accessible route monolith**

**size** - 190x2250x150mm

**location** - start/end of accessible routes

(this item should only be specified when a wall mounted option is not viable)

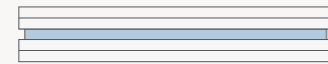

EXT-906

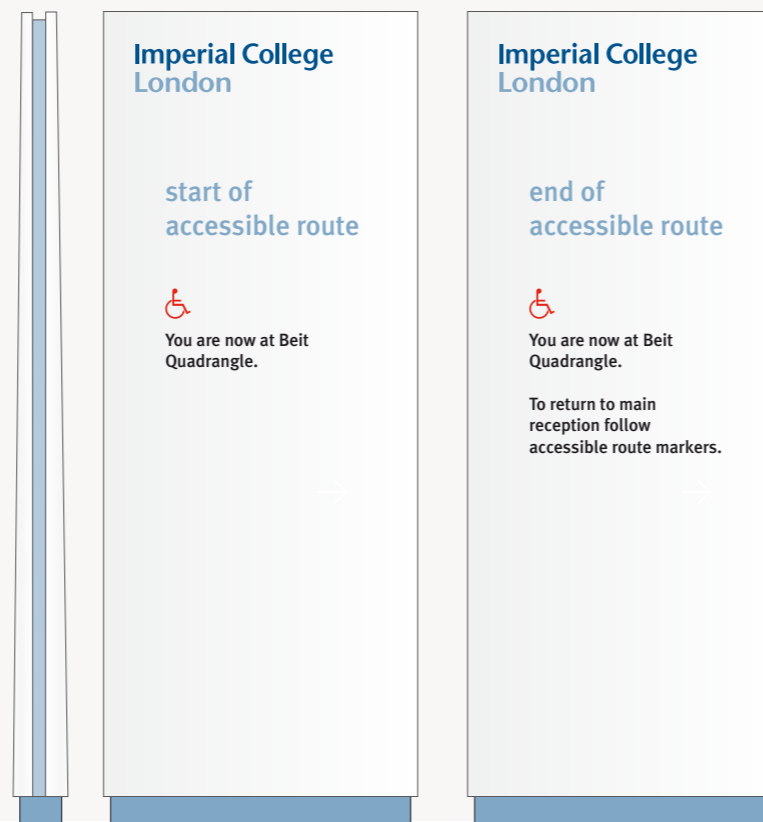

sign type EXT-906a

**start/end of accessible route wall sign**

**size** - 900x1450x40mm

**location** - start/end of accessible routes

EXT-906a

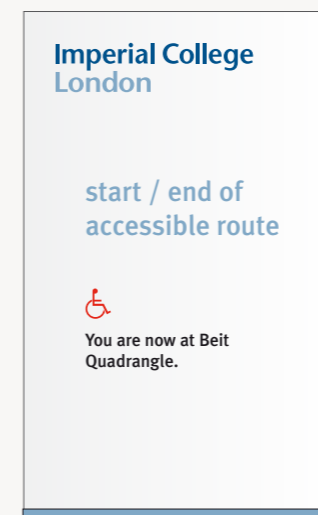

sign type EXT-907

**Parking bay marking indicator sign (on post)**

**size** - 400x1700x100mm

**location** - kerb side of accessible parking bays

EXT-907

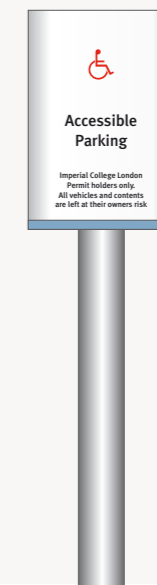

- aluminium monoliths, constructed using 4mm thick aluminium panels supported upon an aluminium box section frame sign framework is to be concreted into the ground (foundations must exceed 1/3rd total sign height beneath ground level)
- parking bay markers to be 3mm aluminium panels mounted onto 100mm posts

## external directional signs

The top and bottom band is a necessary device to aid the visually impaired when the signs are on light coloured exterior walls.

Accessible route marker text is added to exterior signs located along designated routes

EXT-101  
wall mounted directional

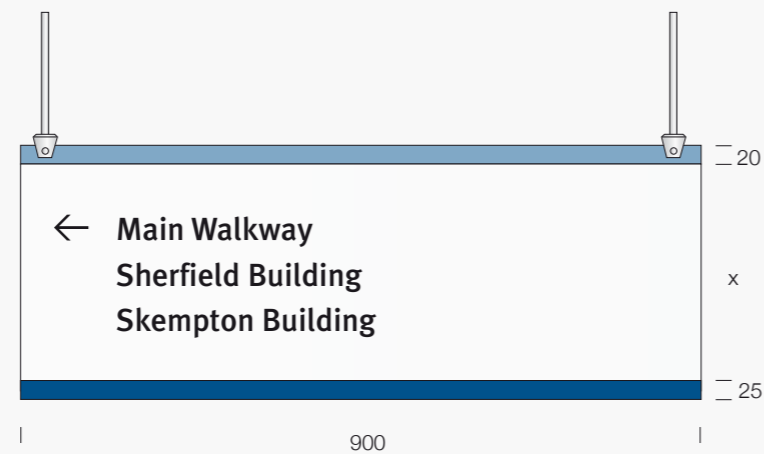
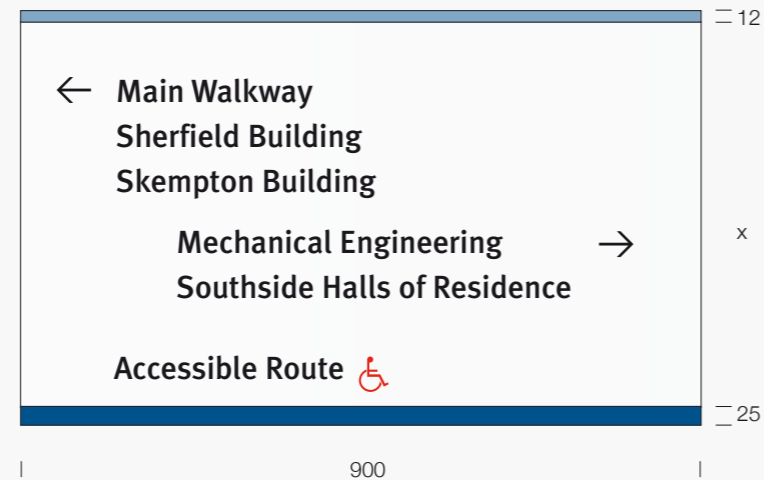

EXT-102  
suspended directional  
*(this item should only be specified when a wall mounted option is not viable)*

EXT-103  
wall mounted lecture theatre sign

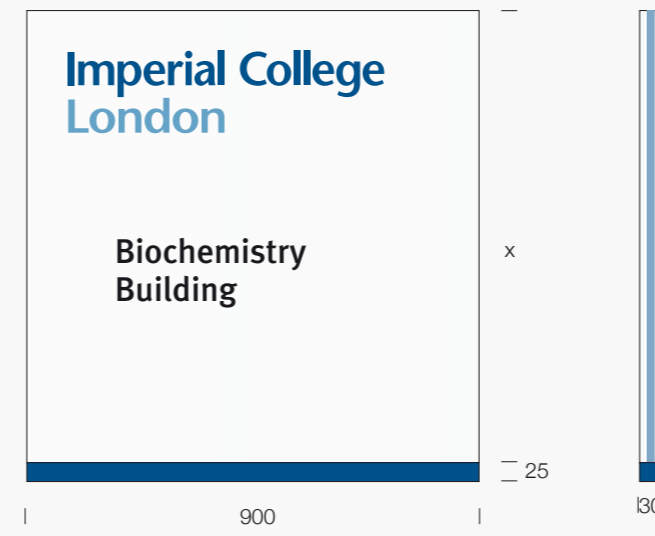
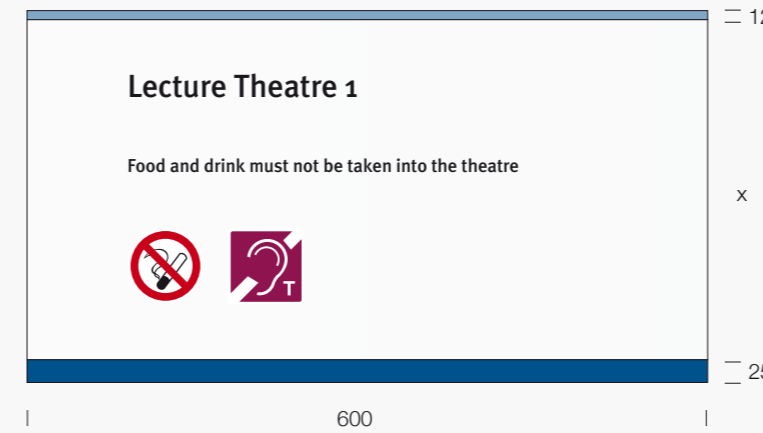

EXT-104  
standard building name  
900 x 950mm  
750 x 795mm  
600 x 640mm  
450 x 485mm  
300 x 335mm

EXT-105  
listed building name sign - silver

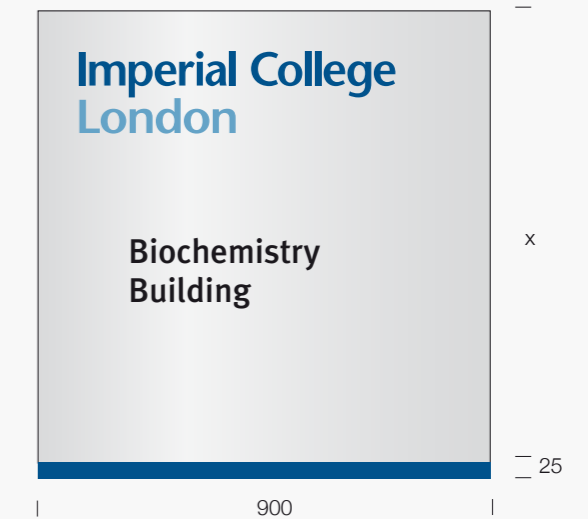

900 x 950mm  
750 x 795mm  
600 x 640mm  
450 x 485mm  
300 x 335mm

## internal directional signs

Interior directional signs have been designed as a reverse image of the new exterior scheme, in order to create a clear contrast between outside routes and those through buildings.

Interior signs are Equality Act 2010 compliant and retain a similar background colour scheme to those already in existence within some buildings. This enables the University to implement an internal scheme over a longer period of time than with the exterior scheme.

An accessible route marker panel has been added to interior signs along designated interior routes.

For correct positioning of these signs within a building see page 19.

INT-101  
wall mounted directional

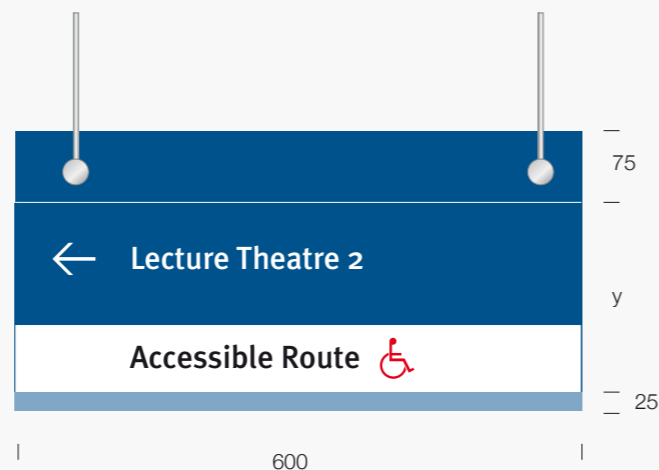
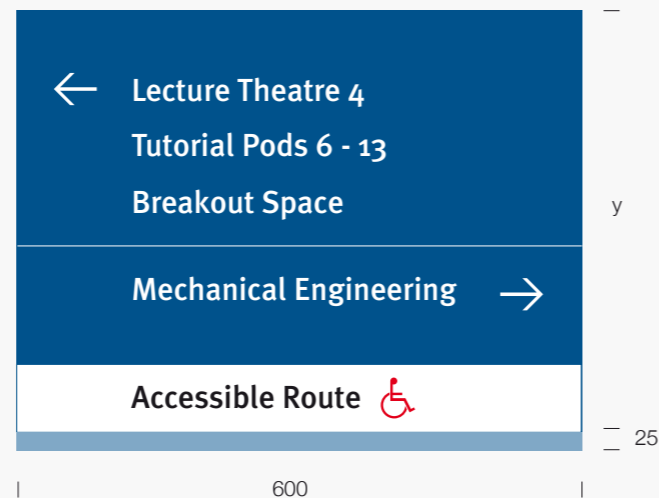

INT-102  
**Suspended directional**  
*(this item should only be specified when  
a wall mounted option is not viable)*

INT-103  
wall mounted lecture theatre sign

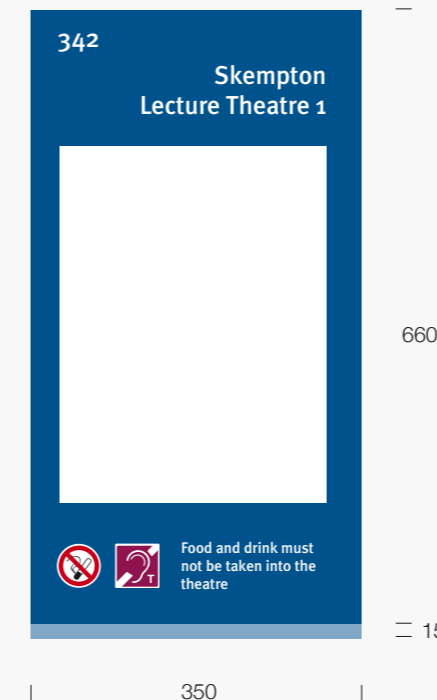

INT-104  
building name tray sign

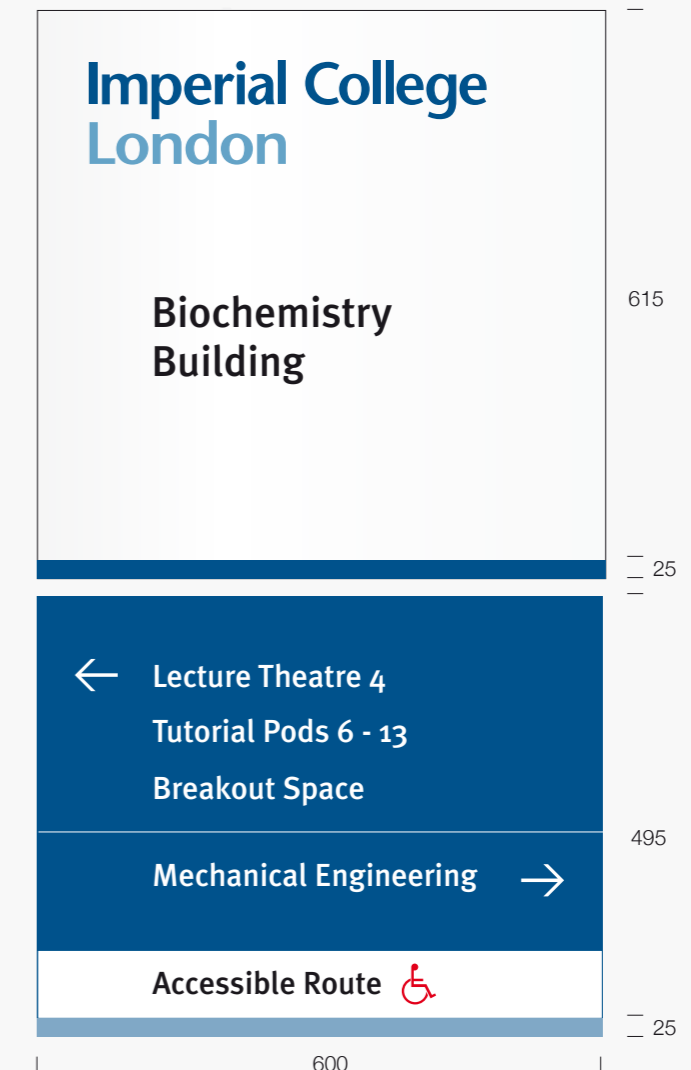

The item illustrated here is to show positioning only.

## internal floor directories

At the top of the sign the building name and floor level should be highlighted on a white panel that also supports the University brand.

Floor directory signs should list key rooms and departments in alphabetical order. Toilets and way out messages should be listed at the bottom of each department list.

A digitally printed map with you are here marker should be included to immediately orientate and familiarise the user with their surroundings.

For preferred positioning of these signs see page 19.

INT-105a  
floor directories

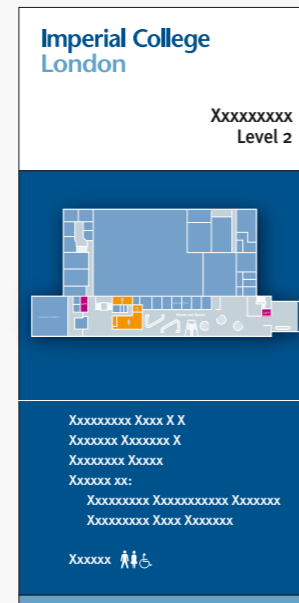

INT-105b  
all floor directories



INT-105c  
entrance directories



INT-105d  
floor indicator



INT-105e  
floor indicator



## notice boards

Noticeboards are often a weak link in a University's communication / signage strategy. Good quality, colour co-ordinated noticeboards are an important feature of a successful interior wayfinding scheme. To be located at consistent points within all buildings.

For preferred positioning of these signs see page 19.

sign type INT-201

### wall mounted pin boards

**size** - 2400x1200mm

**location** - entrances to buildings and departments

**features** - slim aluminium framed notice board with self healing pin board material



sign type INT-202

### wall mounted chalk board

**size** - 2400x1200mm

**location** - within lecture theatre, meeting and seminar rooms

**features** - slim aluminium framed chalk board with easy clean writing surface



sign type INT-203

### lockable cabinets

**size** - 2400x1200mm

**location** - entrances to buildings and departments

**features** - slim aluminium cases with toughened glass inserts, illuminated options available

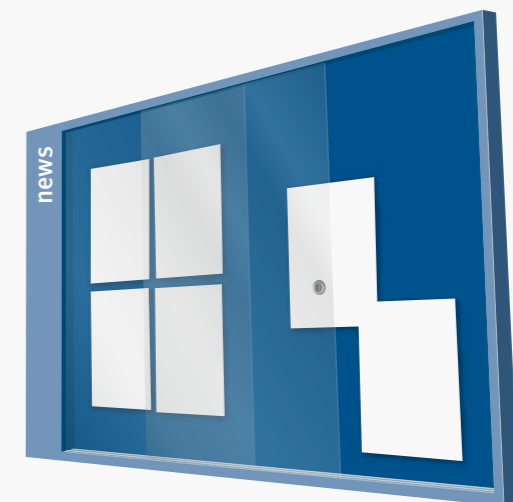

door signs  
(standard)

Door signs must be clear, readable and in a consistent format with options for tactile and Braille features. Door signs enable visitors to know when they have arrived at their room destination.

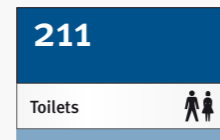

DO211  
**toilets/kitchens/stores/  
single occupancy offices**  
removable paper insert  
behind clear acrylic cover  
140x90mm



DO212  
**plant/switch rooms  
electrical/riser cupboards**  
removable paper insert  
behind clear acrylic cover  
140x145mm

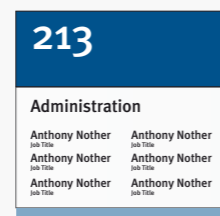

DO213  
**multi-occupancy offices**  
removable paper insert  
behind clear acrylic cover  
140x145mm

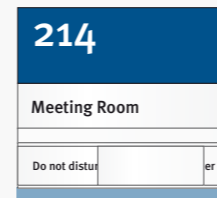

DO214  
**multi-occupancy offices/meeting  
rooms/seminar rooms**  
with vacancy slider and removable  
paper insert behind clear acrylic cover  
140x130mm

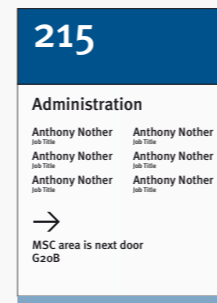

DO215  
**(larger offices)**  
removable paper insert  
behind clear acrylic cover  
140x200mm

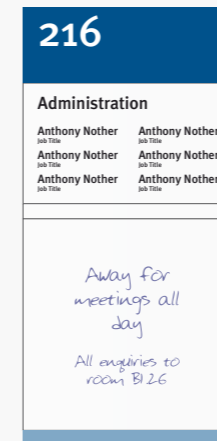

DO216  
**offices (sometimes unmanned)**  
removable paper insert behind clear  
acrylic cover and dry-wipe surface  
140x290mm

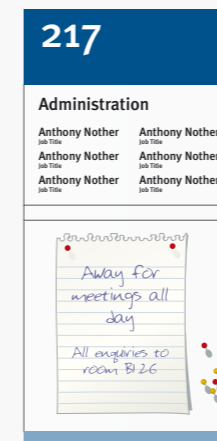

DO217  
**offices (sometimes unmanned)**  
removable paper insert behind clear  
acrylic cover and dry-wipe surface  
140x290mm,

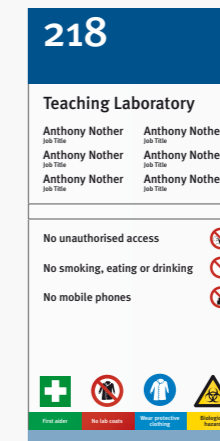

DO218  
**laboratories**  
removable paper insert behind  
clear acrylic cover  
40x290mm

- Modular aluminium door signs with screen printed room numbers & matt lacquer
- Note, If required, an added design feature of locking acrylic covers can be incorporated at extra cost.



door signs  
(residences)

Based upon the main external and internal signage, these signs are slightly altered to accommodate the specific requirements of Halls of Residence.

Specifications remain consistent with main campus signs.

The dual colour scheme shown is preferred but can change to reflect individual building interiors (subject to approval by the Director of Facilities Management)

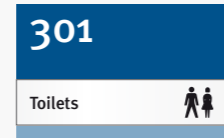

**RES-301**  
**toilets/kitchens/stores**  
Removable paper insert behind clear acrylic cover, 140x90mm

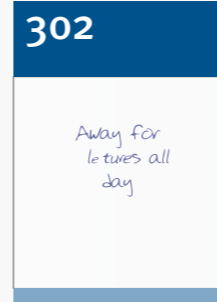

**RES-302 (i)**  
**bedrooms**  
Special dry-wipe surface for easy cleaning, 140x200mm

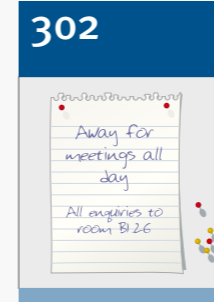

**RES-302 (ii)**  
**bedrooms**  
Pin-board surface for adding temporary notes, 140x200mm

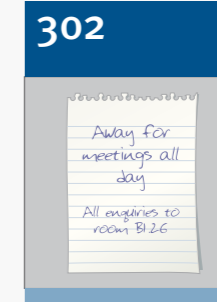

**RES-302 (iii)**  
**bedrooms**  
Replaceable sticky media surface for adding temporary notes, 140x200mm

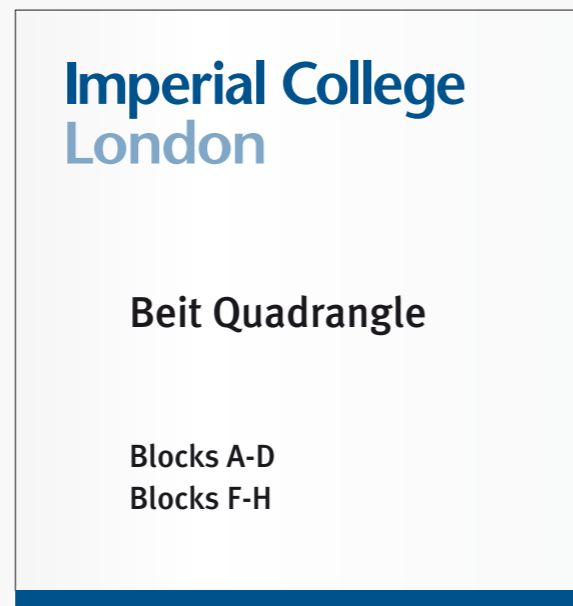

**RES-305**  
**exterior building name**



**RES-306**  
**bike sheds, store rooms**  
Exterior information sign, 300x330mm

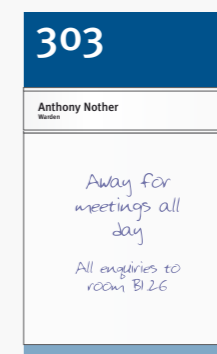

**RES-303**  
**warden/sub-warden**  
Removable paper insert behind clear acrylic cover and special dry-wipe surface, 140x230mm

For directional signs see pages 9 & 10.

- Modular aluminium door signs with screen printed room numbers and matt lacquer.
- Note, If required, an added design feature of locking acrylic covers can be incorporated at extra cost.

door signs  
(non standard)

In exceptional circumstances there is an alternative colour scheme that is designed to fit into new flagship\* buildings. The style, size and typography remain consistent with the standard Imperial College signage. The colour has changed to dark grey.

colours  
anthracite - RAL 7043  
silver - RAL 9006

\* flagship buildings are appointed by the Director of Facilities Management after a project exception report has been submitted

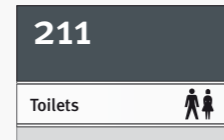

DO211b  
**toilets/kitchens/stores/  
single occupancy offices**  
removable paper insert  
behind clear acrylic cover  
140x90mm

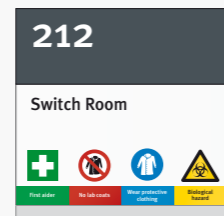

DO212b  
**plant/switch rooms  
electrical/riser cupboards**  
removable paper insert  
behind clear acrylic cover  
140x145mm

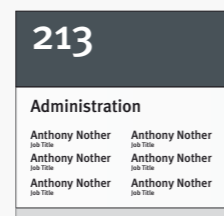

DO213b  
**multi-occupancy offices**  
removable paper insert  
behind clear acrylic cover  
140x145mm

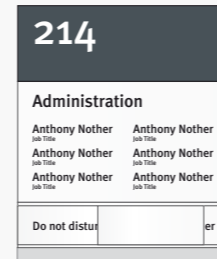

DO214b  
**multi-occupancy offices/meeting  
rooms/seminar rooms**  
with vacancy slider and removable  
paper insert behind clear acrylic cover  
140x175mm

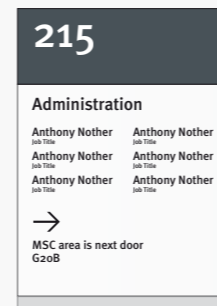

DO215b  
**(larger offices)**  
removable paper insert  
behind clear acrylic cover  
140x200mm

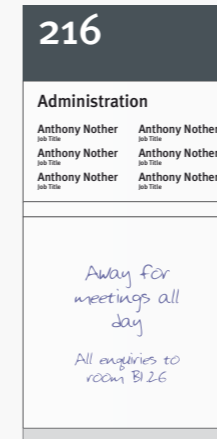

DO216b  
**offices (sometimes unmanned)**  
removable paper insert behind clear  
acrylic cover and dry-wipe surface  
140x290mm

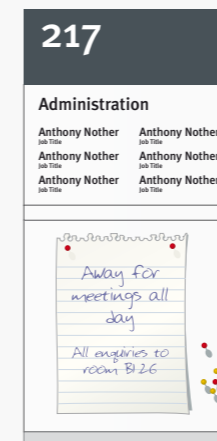

DO217b  
**offices (sometimes unmanned)**  
removable paper insert behind clear  
acrylic cover and dry-wipe surface  
140x290mm

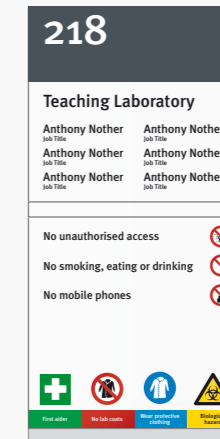

DO218b  
**laboratories**  
removable paper insert behind  
clear acrylic cover  
40x290mm

- Modular aluminium door signs with screen printed room numbers and matt lacquer
- Note, If required, an added design feature of locking acrylic covers can be incorporated at extra cost.

## paper notice holders

Like door signs, paper notice holders must be clear, readable and in a consistent format with options for tactile and Braille features. Paper notice signs enable staff to provide temporary or semi-permanent information to visitors which can be updated quickly and easily in-house as the information changes (i.e. timetables and temporary occupancy of rooms)

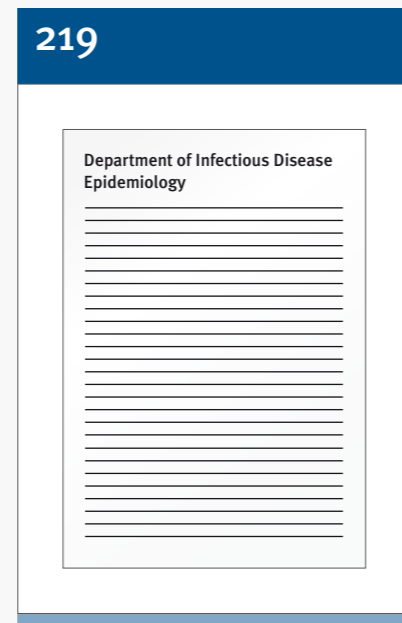

DO219 (i)  
**departmental enquiries**  
A3 or A4 paper holder with hinged acrylic face  
360/270 x 545/425mm



DO219 (ii)  
**departmental enquiries**  
A3 or A4 paper holder with hinged acrylic face and logo header panel  
360/270 x 620/500mm

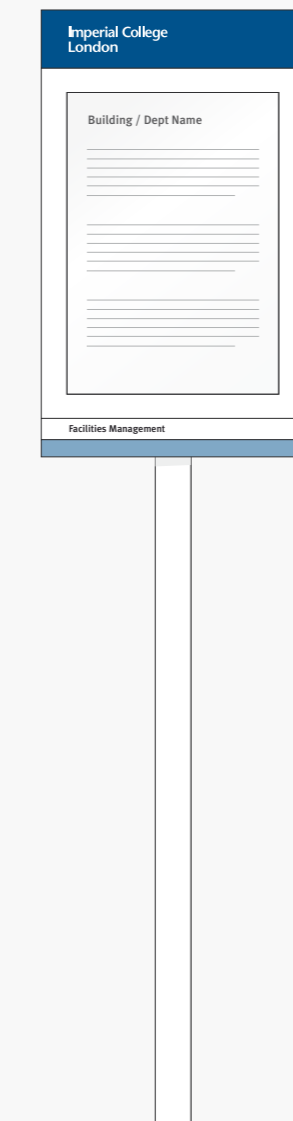

DO219 (iii)  
**free standing: departmental enquiries**  
A3 or A4 paper holder with hinged acrylic face and logo header panel mounted onto a single pedestal.  
360/270 x 620/500mm (1530mm o/all height)

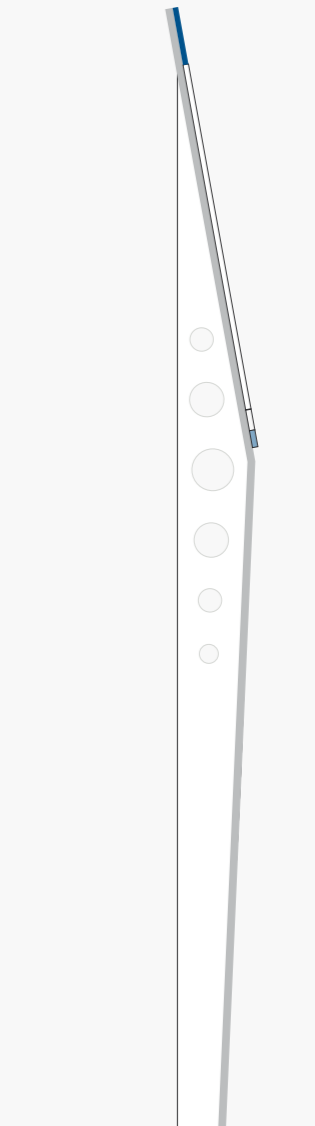

- Modular aluminium door signs with screen printed room numbers & matt lacquer
- Note, If required, an added design feature of locking acrylic covers can be incorporated at extra cost.

## sign positions

When positioning external signs care must be taken to ensure they will not be obscured by plants and vehicles.

Minimise wall mounted & suspended signs where the building is of historical or architectural merit.

Interior free standing and wall mounted directional signs must be positioned and orientated so that they can be easily read from primary circulation routes whilst not acting as an obstruction or congestion point.

Signs read from distance should incorporate text with larger cap heights.

